



woodlore®

2024



SPECIFYING HINTS	5, 6, 7
HAVEN	
Features Overview	8
Instant Offices	9, 10
Photo Feature Page	11
Double Pedestal Desks	12
Single Pedestal Desks	13, 14
Executive Corner Desks	15
Executive P-Top Corner Desks	16
Executive D-Top Corner Desks	17, 18
Returns	19, 20
Returns - Aluminum Legs and Acrylic Panels; Bridges	21
Credenzas - Single Pedestal	22
Credenzas - Double Pedestal	23
Credenzas - Storage & Lateral File	24
Photo Feature Page	25
Reception Workstations	26
Corner Units	27
Specifying Guide - Using Keyboards, Corner Units & Desk Shell Notches	28
Desk Shells	29, 30, 31
Desk Shells with Inset Back Panel; Desk Shell Notches	32
Photo Feature Page	33
Extended Corner Desk Shells	34, 35
D-Tops	36
Photo Feature Page	37
P-Tops	38
Overheads	39, 40, 41
Corner Overheads	42
Overhead Tackboards and Paper Management Options	43
Reception Galleries	44
Extended Corner Reception Galleries	45
Reception Gallery Options	46
Pedestals	47
Lateral Files - Under Desk, Integrated and Stand Alone	48
Lower Storage Units - Under Desk and Freestanding	49
Storage Towers - 24" Wide	50
Storage Towers - 30" and 36" Wide	51
Bookcases	52
Desk Top Panels and Connector Tops	53, 54

.....

ACCESSORIES	55, 56
CONFERENCE ROOM	
Conference Table & Meeting Table Tops	57
Conference Table Bases	58
Photo Feature Page	59
Tables with Aluminum Legs and Acrylic Panels	60
Conference Room and Miscellaneous Furniture	61
WORKSURFACES	62, 63, 64
TERMS and CONDITIONS	Inside back cover

For customer service inquiries, call toll free:

1-866-791-9555

Changes to Product Offering & Finishes

Laminate Finishes

PRODUCT CULLING 2024

Haven Plus

FINISHES -CHANGES/ADDITIONS

New Colours

[New CDN Price List \(www.woodlore.ca/pricing\)](http://www.woodlore.ca/pricing)

[New USD Price List \(www.woodlore.ca/pricing\)](http://www.woodlore.ca/pricing)

Specifying Hints

HAVEN

24 LAMINATE CHOICES	FINISH NAME	COLOUR CODE	APPLICATION - USAGE
Woodgrains	Copacabana Dolce Vita Kensington Maple Monticello Maple Tuxedo White Chocolate	CP DV KM MM TX WC	Available for all surfaces, in all thicknesses
Solid Colours	Folkstone Gray White Black Charcoal	FG WH BK CL	Available for all surfaces, in all thicknesses Not recommended for worksurfaces,

EDGE DETAIL

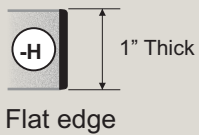

HAVEN

- 1" thick worksurfaces and tops
- 2.5 mm flat edgebanding

HANDLES

Code	Description
 /WHB	Waterfall Handle Black*
 /OPB	Open Pull Black
 /OPN	Open Pull Nickel
 /BPA	Bar Pull Aluminum
 /RPA	Rod Pull Aluminum

HAVEN

- An integral pull is standard on all drawers and doors**
- 5 optional surface-mounted handles available
 - To order add handle code to product code and \$20 per handle to list price
- Surface-mounted handles are standard where shown**
- 5 handle choices available: add handle code to product code
- * **NOTE:** Waterfall Handle Black will be provided as the standard default handle when none is specified

Specifying Hints

SPECIFYING INSTRUCTIONS

HAVEN Example: Double Pedestal Credenza with optional handles

CDP 7220A-H/OPB (CL/MP)

1st - Product Code.....CDP 7220A-H

2nd - Handle Option (if applicable).../OPB

3rd - Laminate Finish (Case/Top)....(CL/MP: Charcoal Case/Maple Top)

GROMMETS (Cable Management)

- Grommets are indicated on all product illustrations when standard
- 2¾" diameter opening
- For non-standard locations, field-installed grommet kits are available (see Accessories - page 55 & 56)
- A no-grommet option is available at no charge for desk shells, extended corner desk shells and corner units

LOCKS

- Locks are standard on all pedestals, credenzas and lateral files
- Locks are optional on all overheads and storage, except where noted
- Locks are pre-installed and 'Keyed-Random' in all workstation components (all multi-lock units are 'Keyed-Alike')
- Workstations are available 'Keyed-Alike' at time of order (see page 7)

PARTIAL HEIGHT BACK PANELS

- Full height back panels are standard
- Partial height back panels are available as a no-charge option on desk shells, extended corner desk shells and corner units
- Pedestal returns are available with an optional open back at no-charge

SIZES

- **Published width and depth dimensions are nominal**
- To determine actual sizes use the multiplier 0.9843... (Example: a desk listed with a nominal width of 60" is actually $60" \times 0.9843 = 59 \frac{1}{16}"$) . . . refer to conversion chart below

Nominal	Actual	Nominal	Actual	Nominal	Actual
24"	23 5/8"	54"	53 1/8"	84"	82 11/16"
30"	29 1/2"	60"	59 1/16"	90"	88 9/16"
36"	35 7/16"	66"	64 15/16"	96"	94 1/2"
42"	41 5/16"	72"	70 7/8"	102"	100 3/8"
48"	47 1/4"	78"	76 3/4"	108"	106 1/4"

Specifying Hints

Keyed-Alike:

- Workstations can be ordered Keyed-Alike; Available at no charge at time of order only
- Entire order must be Keyed-Alike. If some furniture needs to be Keyed-Random place as separate order
- Order as "KAK"; specify total number of locks required and list quantity of each key number
- Key numbers range from #101 to #150
- Refer to attached chart for multi-lock products; all other products have one lock
- Example: Order 18 KAK and in the description specify: (2 each of #101-104; 3 each of #105, 106; 4 of #107)

When specifying 'Keyed-Alike' please note that the following products have *more* than one lock:

PRODUCT DESCRIPTION	PRODUCT CODE	LOCK QTY
Credenza - Double lateral File	CFF	2
Credenza - Double Pedestal	CDP	2
Credenza - Double Pedestal and Center Storage	CZ	3
Credenza - Double Storage	CSS	2
Credenza - Lateral File & Storage	CFS	2
Credenza - Storage & Lateral File	CSF	2
Desk - Bowfront Double Pedestal	BDP	2
Desk - Double Pedestal	DP	2
Lateral File - 3 Drawer	SLF3	2
Lateral File - 4 drawer	SLF4	2
Overhead - with Lock Option (48" - 78" wide) - with 3 or 4 Doors	OD/L	2
Overhead - Wall Mount - with Lock Option (48" - 78" wide)	WMOD/L	2
Storage and File Cabinet	BSCTL/BSCL	2
Storage Tower with Lateral File - with upper storage lock option	FS/L	2

The Haven furniture offering consists of an extensive portfolio of products designed to address today's workplace needs. Freestanding, modular components come together to provide intelligent solutions that support and enhance the work environment.

Features Overview

- **All worksurfaces, tops and end panels are 1" thick**
- **Freestanding independent components provide maximum flexibility**
- **Most product is shipped pre-assembled. Products that are shipped ready-to-configure have most fittings pre-attached for quick installation**
- **All surfaces are manufactured using high-performance thermally fused laminate, providing a durable, resilient finish**
- **Matching edgebanding is 2.5mm thick ABS**
- **Woodgrain direction on doors and drawer fronts is vertical and grain-matched except where noted**
- **Integral pulls are standard on drawers and doors**
- **5 surface-mounted handle options available (see page 4)**
- **Pedestals accommodate both letter and legal filing**

Haven - Instant Offices

HAVEN

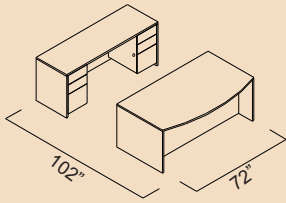

Example 1

Product	Description	Page #
BDP 7242B-H	Bow Front Double Pedestal Desk	12
CDP 7224B-H	Double Pedestal Credenza	23

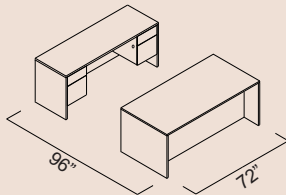

Example 2

Product	Description	Page #
DP 7236A-H	Double Pedestal Desk	12
CDP 7224A-H	Double Pedestal Credenza	23

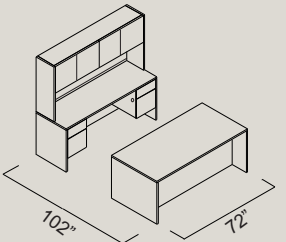

Example 3

Product	Description	Page #
DP 7236A-H	Double Pedestal Desk	12
CDP 7224A-H	Double Pedestal Credenza	23
OD 7236-H	Closed Overhead	39

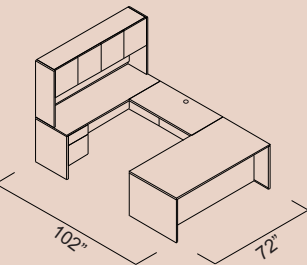

Example 4

Product	Description	Page #
SPR 7236A-H	Single Pedestal Desk - Right	14
BR 4820-H	Bridge	21
CPL 7220A-H	Single Pedestal Credenza - Left	22
OD 7236-H	Closed Overhead	39

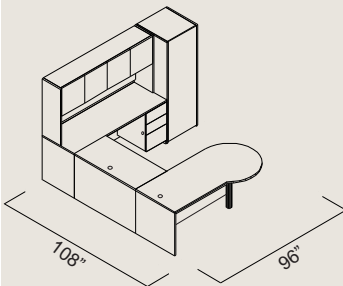

Example 5

Product	Description	Page #	List
PLM 7236-H	P-Top with Modesty	38	
BR 4824-H	Bridge	21	
CPR 7224B-H	Single Pedestal Credenza - Right Box/Box/File	22	
SW 242465R-H	Storage & Wardrobe Tower	50	
OD 7236-H	Closed Overhead	39	

Haven - Instant Offices

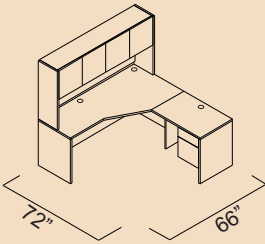

Example 6

Product	Description	Page #
CDLB 6624-H	Corner Desk Shell Extended Left	34
DB 3624-H	Desk Shell	30
HBF-H	Hanging Pedestal Box/File	47
OD 6636-H	Closed Overhead	39

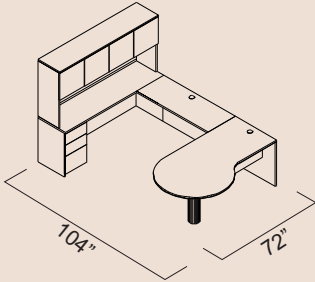

Example 7

Product	Description	Page #
PRM 7242-H	P-Top with Modesty Panel	38
BR 4220-H	Bridge	21
CPL 7220B-H	Single Pedestal Credenza-Left Box/Box/File	22
OD 7236-H	Closed Overhead T	39

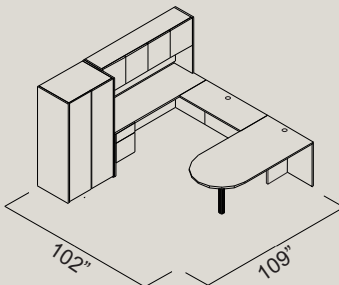

Example 8

Product	Description	Page #
DF 7230-H	D-Top	36
BR 4824-H	Bridge	21
CPL 7224A-H	Single Pedestal Credenza - Left	22
SW 362465-H	Storage & Wardrobe Tower	51
OD 7236-H	Closed Overhead	39

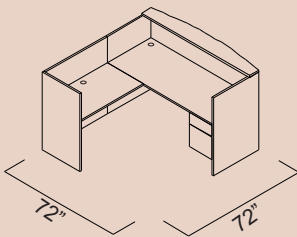

Example 9

Product	Description	Page #
GDBR 7236A-H	Bow Front Reception Desk - Right	26
GRL 4224-H	Reception Return - Left	26

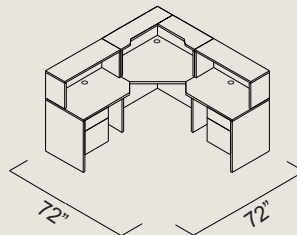

Example 10

Product	Description	Page #
DB 3624-H/NR	Desk Shell Left - Notch Right	30,32
HBF-H	Hanging Pedestal	47
CC 361818-H	Corner Unit	27
DB 3624-H/NL	Desk Shell Right - Notch Left	30,32
HBF-H	Hanging Pedestal	47
OSGC 36-H	Corner Reception Gallery	44
OSG 36-H	Reception Gallery (Qty of 2)	44



VERSATILE







Standard & Bow Front Double Pedestal Desks

Features:

- 1" thick work surface
- Full height inset back panel (Inset is 2½" for 30" desks, 8¾" for 36" desks and 14¾" for 42" desks)
- Bow Front desk top extends 6" on visitor side
- Desk standard without grommets. See page 55 for field-installed grommet option
- Locking pedestals standard and keyed-alike; full depth drawers maximize storage capacity
- Heavy duty full extension ball bearing drawer slides
- Black integral pull standard. For optional silver finish add suffix (/FPS) to product code
- Optional surface-mounted handles available at \$20 each (see page 5)
- 84" desks have centre support panel
- Shipped assembled

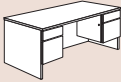

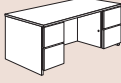
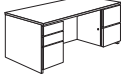
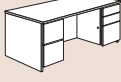
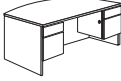
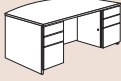
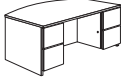
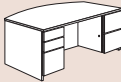
HAVEN



	Product Code	List Price	Dimensions W D H	Wt lbs	Cube ft ³
DOUBLE PEDESTAL DESK - Pedestal Option A  - 2 box/file pedestals	DP 6030A-H		60 30 29	245	32
	DP 6630A-H		66 30 29	255	35
	DP 7230A-H		72 30 29	265	38
	DP 7236A-H		72 36 29	275	45
	DP 8436A-H		84 36 29	285	53
DOUBLE PEDESTAL DESK - Pedestal Option B  - 2 box/box/file pedestals - Upper box non-locking	DP 6030B-H		60 30 29	305	32
	DP 6630B-H		66 30 29	315	35
	DP 7230B-H		72 30 29	325	38
	DP 7236B-H		72 36 29	335	45
	DP 8436B-H		84 36 29	345	53
DOUBLE PEDESTAL DESK - Pedestal Option C  - 2 file/file pedestals	DP 6030C-H		60 30 29	305	32
	DP 6630C-H		66 30 29	315	35
	DP 7230C-H		72 30 29	325	38
	DP 7236C-H		72 36 29	335	45
	DP 8436C-H		84 36 29	345	53
DOUBLE PEDESTAL DESK - Pedestal Option F  - 1 box/box/file pedestal - left - Upper box non-locking - 1 file/file pedestal - right	DP 6030F-H		60 30 29	305	32
	DP 6630F-H		66 30 29	315	35
	DP 7230F-H		72 30 29	325	38
	DP 7236F-H		72 36 29	335	45
	DP 8436F-H		84 36 29	345	53
DOUBLE PEDESTAL DESK - Pedestal Option G  - 1 file/file pedestal - left - 1 box/box/file pedestal - right - Upper box non-locking	DP 6030G-H		60 30 29	305	32
	DP 6630G-H		66 30 29	315	35
	DP 7230G-H		72 30 29	325	38
	DP 7236G-H		72 36 29	335	45
	DP 8436G-H		84 36 29	345	53
DOUBLE PEDESTAL BOW FRONT DESK - Pedestal Option A  - 2 box/file pedestals	BDP 6636A-H		66 36 29	260	42
	BDP 7242A-H		72 42 29	280	53
	BDP 8442A-H		84 42 29	290	62
DOUBLE PEDESTAL BOW FRONT DESK - Pedestal Option B  - 2 box/box/file pedestals - Upper box non-locking	BDP 6636B-H		66 36 29	320	42
	BDP 7242B-H		72 42 29	340	53
	BDP 8442B-H		84 42 29	350	62
DOUBLE PEDESTAL BOW FRONT DESK - Pedestal Option C  - 2 file/file pedestals	BDP 6636C-H		66 36 29	320	42
	BDP 7242C-H		72 42 29	340	53
	BDP 8442C-H		84 42 29	350	62
DOUBLE PEDESTAL BOW FRONT DESK - Pedestal Option F  - 1 box/box/file pedestal - left - Upper box non-locking - 1 file/file pedestal - right	BDP 6636F-H		66 36 29	320	42
	BDP 7242F-H		72 42 29	340	53
	BDP 8442F-H		84 42 29	350	62
DOUBLE PEDESTAL BOW FRONT DESK - Pedestal Option G  - 1 file/file pedestal - left - 1 box/box/file pedestal - right - Upper box non-locking	BDP 6636G-H		66 36 29	320	42
	BDP 7242G-H		72 42 29	340	53
	BDP 8442G-H		84 42 29	350	62



Standard & Bow Front Single Pedestal Desks - Left

Features:

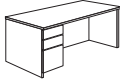
- 1" thick worksurface
- Full height inset back panel (Inset is 2½" for 30" desks, 8¾" for 36" and 14¾" for 42" desks)
- Bow Front desk top extends 6" on visitor side.
- Desk standard without grommets. See page 55 for field-installed grommet option
- Locking pedestal standard; full depth drawers maximize storage capacity
- Heavy duty full extension ball bearing drawer slides
- Black integral pull standard. For optional silver finish add suffix (/FPS) to product code
- Optional surface-mounted handles available at \$20 each (see page 5)
- 84" desks have centre support panel
- Shipped assembled

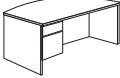
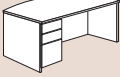
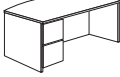
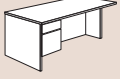
	Product Code	List Price	Dimensions			Wt lbs	Cube ft ³
			W	D	H		
SINGLE PEDESTAL DESK - LEFT - Pedestal Option A  - Box/file pedestal	SPL 4830A-H		48	30	29	170	26
	SPL 5430A-H		54	30	29	180	29
	SPL 6030A-H		60	30	29	190	32
	SPL 6630A-H		66	30	29	200	35
	SPL 7230A-H		72	30	29	210	38
	SPL 7236A-H		72	36	29	220	45
	SPL 8436A-H		84	36	29	230	53
SINGLE PEDESTAL DESK - LEFT - Pedestal Option B  - Box/box/file pedestal - Upper box non-locking	SPL 4830B-H		48	30	29	200	26
	SPL 5430B-H		54	30	29	210	29
	SPL 6030B-H		60	30	29	220	32
	SPL 6630B-H		66	30	29	230	35
	SPL 7230B-H		72	30	29	240	38
	SPL 7236B-H		72	36	29	250	45
	SPL 8436B-H		84	36	29	260	53
SINGLE PEDESTAL DESK - LEFT - Pedestal Option C  - File/file pedestal	SPL 4830C-H		48	30	29	200	26
	SPL 5430C-H		54	30	29	210	29
	SPL 6030C-H		60	30	29	220	32
	SPL 6630C-H		66	30	29	230	35
	SPL 7230C-H		72	30	29	240	38
	SPL 7236C-H		72	36	29	250	45
	SPL 8436C-H		84	36	29	260	53
SINGLE PEDESTAL BOW FRONT DESK - LEFT - Pedestal Option A  - Box/file pedestal	BSPL 6636A-H		66	36	29	205	42
	BSPL 7242A-H		72	42	29	225	53
	BSPL 8442A-H		84	42	29	235	62
SINGLE PEDESTAL BOW FRONT DESK - LEFT - Pedestal Option B  - Box/box/file pedestal - Upper box non-locking	BSPL 6636B-H		66	36	29	235	42
	BSPL 7242B-H		72	42	29	255	53
	BSPL 8442B-H		84	42	29	265	62
SINGLE PEDESTAL BOW FRONT DESK - LEFT - Pedestal Option C  - File/file pedestal	BSPL 6636C-H		66	36	29	235	42
	BSPL 7242C-H		72	42	29	255	53
	BSPL 8442C-H		84	42	29	265	62
OPTIONS							
CUTAWAY END PANEL - RIGHT  - Replaces 30" or 36" right end panel - Add suffix (/CGR) to product code - Not available for Bow Front Desk	/CGR		n/a	n/a	n/a	n/a	n/a

Standard & Bow Front Single Pedestal Desks - Right

Features:

- 1" thick worksurface
- Full height inset back panel (Inset is 2½" for 30" desks, 8¾" for 36" and 14¾" for 42" desks)
- Bow Front desk top extends 6" on visitor side.
- Desk standard without grommets. See page 55 for field-installed grommet option
- Locking pedestal standard; full depth drawers maximize storage capacity
- Heavy duty full extension ball bearing drawer slides
- Black integral pull standard. For optional silver finish add suffix (/FPS) to product code
- Optional surface-mounted handles available at \$20 each (see page 5)
- 84" desks have centre support panel
- Shipped assembled



HAVEN

SINGLE PEDESTAL DESK - RIGHT- Pedestal Option A

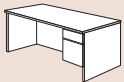

- Box/file pedestal

SINGLE PEDESTAL DESK - RIGHT- Pedestal Option B

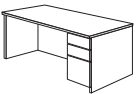

- Box/box/file pedestal
- Upper box non-locking

SINGLE PEDESTAL DESK - RIGHT- Pedestal Option C

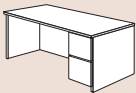

- File/file pedestal

SINGLE PEDESTAL BOW FRONT DESK - RIGHT - Pedestal Option A

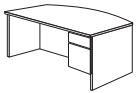

- Box/file pedestal

SINGLE PEDESTAL BOW FRONT DESK - RIGHT - Pedestal Option B

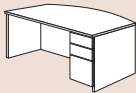

- Box/box/file pedestal
- Upper box non-locking

SINGLE PEDESTAL BOW FRONT DESK - RIGHT - Pedestal Option C



- File/file pedestal

OPTIONS

CUTAWAY END PANEL - LEFT

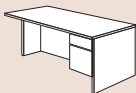

- Replaces 30" or 36" left end panel
- Add suffix (/CGL) to product code
- Not available for Bow Front Desk

Product Code	List Price	Dimensions			Wt lbs	Cube ft ³
		W	D	H		
SPR 4830A-H		48	30	29	170	26
SPR 5430A-H		54	30	29	180	29
SPR 6030A-H		60	30	29	190	32
SPR 6630A-H		66	30	29	200	35
SPR 7230A-H		72	30	29	210	38
SPR 7236A-H		72	36	29	220	45
SPR 8436A-H		84	36	29	230	53
SPR 4830B-H		48	30	29	200	26
SPR 5430B-H		54	30	29	210	29
SPR 6030B-H		60	30	29	220	32
SPR 6630B-H		66	30	29	230	35
SPR 7230B-H		72	30	29	240	38
SPR 7236B-H		72	36	29	250	45
SPR 8436B-H		84	36	29	260	53
SPR 4830C-H		48	30	29	200	26
SPR 5430C-H		54	30	29	210	29
SPR 6030C-H		60	30	29	220	32
SPR 6630C-H		66	30	29	230	35
SPR 7230C-H		72	30	29	240	38
SPR 7236C-H		72	36	29	250	45
SPR 8436C-H		84	36	29	260	53
BSPR 6636A-H		66	36	29	205	42
BSPR 7242A-H		72	42	29	225	53
BSPR 8442A-H		84	42	29	235	62
BSPR 6636B-H		66	36	29	235	42
BSPR 7242B-H		72	42	29	255	53
BSPR 8442B-H		84	42	29	265	62
BSPR 6636C-H		66	36	29	235	42
BSPR 7242C-H		72	42	29	255	53
BSPR 8442C-H		84	42	29	265	62
/CGL		n/a	n/a	n/a	n/a	n/a

Executive Corner Desks



* pedestal ordered separately

Features:

- 1" thick worksurface
- Bow Front desk top extends 6" on visitor side
- Full height back panel, inset 14¼"
- For pedestal options, see page 47
- For return options, see pages 19, 20, 21 and 31

* Optional pedestals not recommended for 6630 desks

HAVEN

EXTENDED LEFT - STRAIGHT CUTAWAY

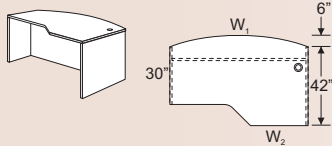

EXTENDED RIGHT - STRAIGHT CUTAWAY

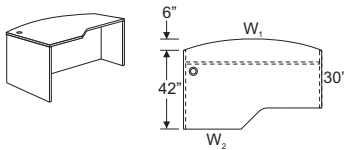

EXTENDED LEFT - CURVED CUTAWAY

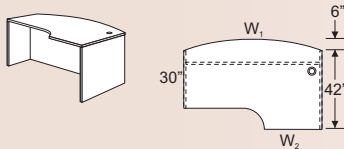

EXTENDED RIGHT - CURVED CUTAWAY

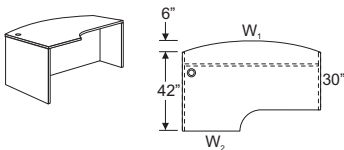

Product Code	List Price	Dimensions				Wt lbs	Cube ft ³
		W ₁	W ₂	D	H		
ECDS 6620L-H		66	20	48	29	165	9
ECDS 6624L-H		66	24	48	29	165	9
ECDS 6630L-H*		66	30	48	29	165	9
ECDS 7220L-H		72	20	48	29	175	9
ECDS 7224L-H		72	24	48	29	175	9
ECDS 7230L-H		72	30	48	29	175	9
ECDS 7820L-H		78	20	48	29	186	10
ECDS 7824L-H		78	24	48	29	186	10
ECDS 7830L-H		78	30	48	29	186	10
ECDS 6620R-H		66	20	48	29	165	9
ECDS 6624R-H		66	24	48	29	165	9
ECDS 6630R-H*		66	30	48	29	165	9
ECDS 7220R-H		72	20	48	29	175	9
ECDS 7224R-H		72	24	48	29	175	9
ECDS 7230R-H		72	30	48	29	175	9
ECDS 7820R-H		78	20	48	29	186	10
ECDS 7824R-H		78	24	48	29	186	10
ECDS 7830R-H		78	30	48	29	186	10
ECDC 6620L-H		66	20	48	29	165	9
ECDC 6624L-H		66	24	48	29	165	9
ECDC 6630L-H*		66	30	48	29	165	9
ECDC 7220L-H		72	20	48	29	175	9
ECDC 7224L-H		72	24	48	29	175	9
ECDC 7230L-H		72	30	48	29	175	9
ECDC 7820L-H		78	20	48	29	186	10
ECDC 7824L-H		78	24	48	29	186	10
ECDC 7830L-H		78	30	48	29	186	10
ECDC 6620R-H		66	20	48	29	165	9
ECDC 6624R-H		66	24	48	29	165	9
ECDC 6630R-H*		66	30	48	29	165	9
ECDC 7220R-H		72	20	48	29	175	9
ECDC 7224R-H		72	24	48	29	175	9
ECDC 7230R-H		72	30	48	29	175	9
ECDC 7820R-H		78	20	48	29	186	10
ECDC 7824R-H		78	24	48	29	186	10
ECDC 7830R-H		78	30	48	29	186	10

Executive D-Top Corner Desks - 24"

Features:

- 1" thick worksurface
- 6" diameter black post leg standard. For optional silver finish add suffix (/SL) to product code
- Modesty panel 14" high
- For return options see pages 19, 20, 21 and 31

D-TOP LEFT - STRAIGHT CUTAWAY

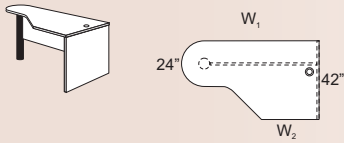

D-TOP RIGHT - STRAIGHT CUTAWAY

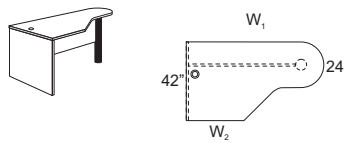

D-TOP LEFT - CURVED CUTAWAY

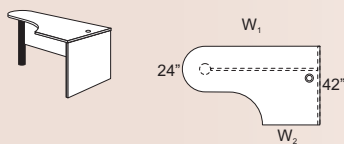

D-TOP RIGHT - CURVED CUTAWAY

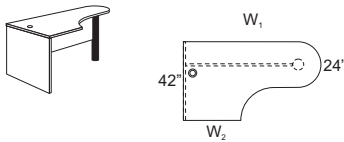

OPTIONS

FULL HEIGHT MODESTY PANEL

- Add suffix (/FMP) to product code

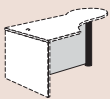

Product Code	List Price	Dimensions				Wt Cube	
		W ₁	W ₂	D	H	lbs	ft ³
DTCS 662420L-H		66	20	42	29	123	8
DTCS 662424L-H		66	24	42	29	123	8
DTCS 662430L-H		66	30	42	29	123	8
DTCS 722420L-H		72	20	42	29	130	8
DTCS 722424L-H		72	24	42	29	130	8
DTCS 722430L-H		72	30	42	29	130	8
DTCS 782420L-H		78	20	42	29	138	9
DTCS 782424L-H		78	24	42	29	138	9
DTCS 782430L-H		78	30	42	29	138	9
DTCS 662420R-H		66	20	42	29	123	8
DTCS 662424R-H		66	24	42	29	123	8
DTCS 662430R-H		66	30	42	29	123	8
DTCS 722420R-H		72	20	42	29	130	8
DTCS 722424R-H		72	24	42	29	130	8
DTCS 722430R-H		72	30	42	29	130	8
DTCS 782420R-H		78	20	42	29	138	9
DTCS 782424R-H		78	24	42	29	138	9
DTCS 782430R-H		78	30	42	29	138	9
DTCC 662420L-H		66	20	42	29	123	8
DTCC 662424L-H		66	24	42	29	123	8
DTCC 662430L-H		66	30	42	29	123	8
DTCC 722420L-H		72	20	42	29	130	8
DTCC 722424L-H		72	24	42	29	130	8
DTCC 722430L-H		72	30	42	29	130	8
DTCC 782420L-H		78	20	42	29	138	9
DTCC 782424L-H		78	24	42	29	138	9
DTCC 782430L-H		78	30	42	29	138	9
DTCC 662420R-H		66	20	42	29	123	8
DTCC 662424R-H		66	24	42	29	123	8
DTCC 662430R-H		66	30	42	29	123	8
DTCC 722420R-H		72	20	42	29	130	8
DTCC 722424R-H		72	24	42	29	130	8
DTCC 722430R-H		72	30	42	29	130	8
DTCC 782420R-H		78	20	42	29	138	9
DTCC 782424R-H		78	24	42	29	138	9
DTCC 782430R-H		78	30	42	29	138	9
/FMP		n/a	5/8	28		n/a	n/a

Returns - Left



Features:

- 1" thick worksurface
- One grommet centre rear
- Pedestal standard locking, with heavy duty full extension ball bearing drawer slides
- Back panels have vertical wood grain pattern to match adjacent desk end panel
- Black integral pull standard. For optional silver finish add suffix (/FPS) to product code
- Optional surface-mounted handles available at \$20 each (see page 5)
- Optional open back panel available for Pedestal Returns only
- Pedestal returns shipped assembled; Non-ped returns shipped ready-to-assemble

PEDESTAL RETURN LEFT - Pedestal Option A

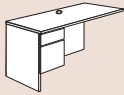

- Box/file pedestal

PEDESTAL RETURN LEFT - Pedestal Option B



- Box/box/file pedestal
- Upper box non-locking

PEDESTAL RETURN LEFT - Pedestal Option C

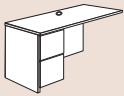

- File/file pedestal

20" RETURN LEFT - NO PED

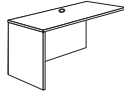

- Can not accommodate field-installed hanging and mobile pedestal options

24" RETURN LEFT - NO PED

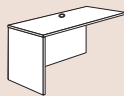

- Can accommodate field-installed hanging and mobile pedestal options

OPTIONS

Note: Do not use this option if return is supporting overhead storage unit

OPEN BACK PED RETURN



- Add suffix (/OB) to product code

Product Code	List Price	Dimensions			Wt Cube	
		W	D	H	lbs	ft ³
RL 3020A-H		30	20	29	98	13
RL 3620A-H		36	20	29	105	15
RL 4220A-H		42	20	29	113	18
RL 4820A-H		48	20	29	120	20
RL 5420A-H		54	20	29	128	23
RL 6020A-H		60	20	29	135	25
RL 3024A-H		30	24	29	103	13
RL 3624A-H		36	24	29	110	15
RL 4224A-H		42	24	29	118	18
RL 4824A-H		48	24	29	125	20
RL 5424A-H		54	24	29	133	23
RL 6024A-H		60	24	29	140	25
RL 3020B-H		30	20	29	128	13
RL 3620B-H		36	20	29	135	15
RL 4220B-H		42	20	29	143	18
RL 4820B-H		48	20	29	150	20
RL 5420B-H		54	20	29	158	23
RL 6020B-H		60	20	29	165	25
RL 3024B-H		30	24	29	133	13
RL 3624B-H		36	24	29	140	15
RL 4224B-H		42	24	29	148	18
RL 4824B-H		48	24	29	155	20
RL 5424B-H		54	24	29	163	23
RL 6024B-H		60	24	29	170	25
RL 3020C-H		30	20	29	128	13
RL 3620C-H		36	20	29	135	15
RL 4220C-H		42	20	29	143	18
RL 4820C-H		48	20	29	150	20
RL 5420C-H		54	20	29	158	23
RL 6020C-H		60	20	29	165	25
RL 3024C-H		30	24	29	133	13
RL 3624C-H		36	24	29	140	15
RL 4224C-H		42	24	29	148	18
RL 4824C-H		48	24	29	155	20
RL 5424C-H		54	24	29	163	23
RL 6024C-H		60	24	29	170	25
FRL 3020-H		30	20	29	68	3
FRL 3620-H		36	20	29	70	3
FRL 4220-H		42	20	29	73	3
FRL 4820-H		48	20	29	75	4
FRL 5420-H		54	20	29	78	4
FRL 6020-H		60	20	29	80	4
FRL 3024-H		30	24	29	68	3
FRL 3624-H		36	24	29	70	3
FRL 4224-H		42	24	29	73	3
FRL 4824-H		48	24	29	75	4
FRL 5424-H		54	24	29	78	4
FRL 6024-H		60	24	29	80	4
OPTIONS						
OPEN BACK PED RETURN	- Add suffix (/OB) to product code	/OB	n/a	n/a	n/a	n/a

Returns - Right

Features:

- 1" thick worksurface
- One grommet centre rear
- Pedestal standard locking, with heavy duty full extension ball bearing drawer slides
- Back panels have vertical wood grain pattern to match adjacent desk end panel
- Black integral pull standard. For optional silver finish add suffix (/FPS) to product code
- Optional surface-mounted handles available at \$20 each (see page 5)
- Optional open back panel available for Pedestal Returns only
- Pedestal returns shipped assembled; Non-ped returns shipped ready-to-assemble



HAVEN

PEDESTAL RETURN RIGHT - Pedestal Option A

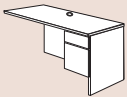

- Box/file pedestal

PEDESTAL RETURN RIGHT - Pedestal Option B

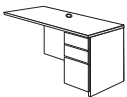

- Box/box/file pedestal
- Upper box non-locking

PEDESTAL RETURN RIGHT - Pedestal Option C

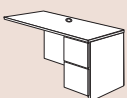

- File/file pedestal

20" RETURN RIGHT - NO PED

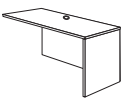

- Can not accommodate field-installed hanging and mobile pedestal options

24" RETURN RIGHT - NO PED

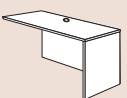

- Can accommodate field-installed hanging and mobile pedestal options

Product Code	List Price	Dimensions			Wt lbs	Cube ft ³
		W	D	H		
RR 3020A-H		30	20	29	98	13
RR 3620A-H		36	20	29	105	15
RR 4220A-H		42	20	29	113	18
RR 4820A-H		48	20	29	120	20
RR 5420A-H		54	20	29	128	23
RR 6020A-H		60	20	29	135	25
RR 3024A-H		30	24	29	103	13
RR 3624A-H		36	24	29	110	15
RR 4224A-H		42	24	29	118	18
RR 4824A-H		48	24	29	125	20
RR 5424A-H		54	24	29	133	23
RR 6024A-H		60	24	29	140	25
RR 3020B-H		30	20	29	128	13
RR 3620B-H		36	20	29	135	15
RR 4220B-H		42	20	29	143	18
RR 4820B-H		48	20	29	150	20
RR 5420B-H		54	20	29	158	23
RR 6020B-H		60	20	29	165	25
RR 3024B-H		30	24	29	133	13
RR 3624B-H		36	24	29	140	15
RR 4224B-H		42	24	29	148	18
RR 4824B-H		48	24	29	155	20
RR 5424B-H		54	24	29	163	23
RR 6024B-H		60	24	29	170	25
RR 3020C-H		30	20	29	128	13
RR 3620C-H		36	20	29	135	15
RR 4220C-H		42	20	29	143	18
RR 4820C-H		48	20	29	150	20
RR 5420C-H		54	20	29	158	23
RR 6020C-H		60	20	29	165	25
RR 3024C-H		30	24	29	133	13
RR 3624C-H		36	24	29	140	15
RR 4224C-H		42	24	29	148	18
RR 4824C-H		48	24	29	155	20
RR 5424C-H		54	24	29	163	23
RR 6024C-H		60	24	29	170	25
FRR 3020-H		30	20	29	68	3
FRR 3620-H		36	20	29	70	3
FRR 4220-H		42	20	29	73	3
FRR 4820-H		48	20	29	75	4
FRR 5420-H		54	20	29	78	4
FRR 6020-H		60	20	29	80	4
FRR 3024-H		30	24	29	68	3
FRR 3624-H		36	24	29	70	3
FRR 4224-H		42	24	29	73	3
FRR 4824-H		48	24	29	75	4
FRR 5424-H		54	24	29	78	4
FRR 6024-H		60	24	29	80	4

OPTIONS **Note: Do not use this option if return is supporting overhead storage unit**

OPEN BACK PED RETURN



- Add suffix (/OB) to product code

/OB

n/a n/a n/a





n/a n/a

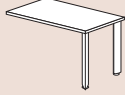
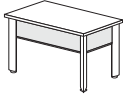
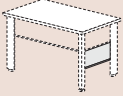
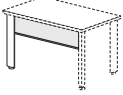

Returns - Aluminum Legs and Acrylic Panels; Bridges

Features:

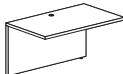
- 1" thick worksurface
- Return standard without grommet. See page 55 for field-installed grommet option
- Aluminum legs with clear anodized finish and wire management capabilities
- For horizontal wire management see page 55

	Product Code	List Price	Dimensions			Wt	Cube
			W	D	H	lbs	ft ³
RETURN WITH ALUMINUM LEGS  <ul style="list-style-type: none"> - Non-handed - Standard with 2 support legs - Optional acrylic end panels 	RAL 4224-H		42	24	29	33	4
	RAL 4824-H		48	24	29	36	4
	RAL 5424-H		54	24	29	40	4
	RAL 6024-H		60	24	29	43	5
	RAL 4230-H		42	30	29	39	4
	RAL 4830-H		48	30	29	43	5
	RAL 5430-H		54	30	29	47	5
	RAL 6030-H		60	30	29	52	5
RETURN WITH ALUMINUM LEGS, ACRYLIC END PANEL & MODESTY PANEL  <ul style="list-style-type: none"> - Non-handed - Standard with 3 support legs, 1 acrylic end panel and modesty panel - Optional add-on acrylic end panel (order separately - see below) 	RAL 4224EM-H		42	24	29	33	4
	RAL 4824EM-H		48	24	29	36	4
	RAL 5424EM-H		54	24	29	40	4
	RAL 6024EM-H		60	24	29	43	5
	RAL 4230EM-H		42	30	29	39	4
	RAL 4830EM-H		48	30	29	43	5
	RAL 5430EM-H		54	30	29	47	5
	RAL 6030EM-H		60	30	29	52	5
ADD-ON ACRYLIC END PANEL  <ul style="list-style-type: none"> - Use to add an end panel to RAL return - Use to create a double end panel on an RAL-EM return 	AEP 24		16	1/4	10	1	1
	AEP 30		22	1/4	10	1	1
ADD-ON ACRYLIC MODESTY PANEL  <ul style="list-style-type: none"> - Not to be used with RAL-EM returns - Includes the 3rd support leg 	AMPL 42		34	1/4	10	3	1
	AMPL 48		40	1/4	10	4	1
	AMPL 54		46	1/4	10	4	1
	AMPL 60		52	1/4	10	5	1
	AMPL 66		58	1/4	10	5	1
	AMPL 72		64	1/4	10	6	1
	20" BRIDGE  <ul style="list-style-type: none"> - Back panel has vertical grain direction 	BR 3020-H		30	20	29	60
BR 3620-H			36	20	29	62	2
BR 4220-H			42	20	29	65	2
BR 4820-H			48	20	29	67	3
BR 5420-H			54	20	29	70	3
BR 6020-H			60	20	29	72	4
24" BRIDGE  <ul style="list-style-type: none"> - Back panel has vertical grain direction 	BR 3024-H		30	24	29	60	2
	BR 3624-H		36	24	29	62	2
	BR 4224-H		42	24	29	65	2
	BR 4824-H		48	24	29	67	3
	BR 5424-H		54	24	29	70	3
	BR 6024-H		60	24	29	72	4
OPTIONS Note: Do not use this option if return is supporting overhead storage unit							
3/4 HEIGHT BACK PANEL  <ul style="list-style-type: none"> - Add suffix (/ 3Q) to product code - Provides 8" clearance above the floor 	/ 3Q		n/a	5/8	20	-3	n/a
1/2 HEIGHT BACK PANEL  <ul style="list-style-type: none"> - Add suffix (/ 2Q) to product code - Provides 14" clearance above the floor 	/ 2Q		n/a	5/8	14	-5	n/a

Single Pedestal Credenzas - Left and Right

Features:

- 1" thick worksurface
- Full height back panel
- Credenzas standard without grommets. See page 55 for field-installed grommet option
- Locking pedestal standard
- Heavy duty full extension ball bearing drawer slides
- Black integral pull standard. For optional silver finish add suffix (/FPS) to product code
- Optional surface-mounted handles available at \$20 each (see page 5)
- Shipped assembled



HAVEN

SINGLE PEDESTAL CREDENZA - LEFT - Pedestal Option A

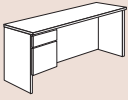

- Box/file pedestal

SINGLE PEDESTAL CREDENZA - LEFT - Pedestal Option B

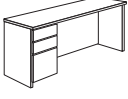

- Box/box/file pedestal
- Upper box non-locking

SINGLE PEDESTAL CREDENZA - LEFT - Pedestal Option C

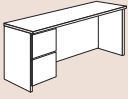

- File/file pedestal

SINGLE PEDESTAL CREDENZA - RIGHT - Pedestal Option A



- Box/file pedestal

SINGLE PEDESTAL CREDENZA - RIGHT - Pedestal Option B

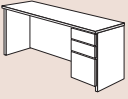

- Box/box/file pedestal
- Upper box non-locking

SINGLE PEDESTAL CREDENZA - RIGHT - Pedestal Option C



- File/file pedestal

Product Code	List Price	Dimensions			Wt lbs	Cube ft ³
		W	D	H		
CPL 6020A-H		60	20	29	160	22
CPL 6620A-H		66	20	29	165	24
CPL 7220A-H		72	20	29	175	26
CPL 6024A-H		60	24	29	165	25
CPL 6624A-H		66	24	29	170	27
CPL 7224A-H		72	24	29	180	30
CPL 6020B-H		60	20	29	190	22
CPL 6620B-H		66	20	29	195	24
CPL 7220B-H		72	20	29	205	26
CPL 6024B-H		60	24	29	195	25
CPL 6624B-H		66	24	29	200	27
CPL 7224B-H		72	24	29	210	30
CPL 6020C-H		60	20	29	190	22
CPL 6620C-H		66	20	29	195	24
CPL 7220C-H		72	20	29	205	26
CPL 6024C-H		60	24	29	195	25
CPL 6624C-H		66	24	29	200	27
CPL 7224C-H		72	24	29	210	30
CPR 6020A-H		60	20	29	160	22
CPR 6620A-H		66	20	29	165	24
CPR 7220A-H		72	20	29	175	26
CPR 6024A-H		60	24	29	165	25
CPR 6624A-H		66	24	29	170	27
CPR 7224A-H		72	24	29	180	30
CPR 6020B-H		60	20	29	190	22
CPR 6620B-H		66	20	29	195	24
CPR 7220B-H		72	20	29	205	26
CPR 6024B-H		60	24	29	195	25
CPR 6624B-H		66	24	29	200	27
CPR 7224B-H		72	24	29	210	30
CPR 6020C-H		60	20	29	190	22
CPR 6620C-H		66	20	29	195	24
CPR 7220C-H		72	20	29	205	26
CPR 6024C-H		60	24	29	195	25
CPR 6624C-H		66	24	29	200	27
CPR 7224C-H		72	24	29	210	30

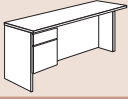
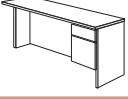
OPTIONS						
CUTAWAY END PANEL - RIGHT						
	- Replaces 20" or 24" right end panel on CPL - Add suffix (/CGR) to product code	/CGR		n/a	n/a	n/a
CUTAWAY END PANEL - LEFT						
	- Replaces 20" or 24" left end panel on CPR - Add suffix (/CGL) to product code	/CGL		n/a	n/a	n/a



Double Pedestal Credenzas

Features:

- 1" thick worksurface
- Full height back panel
- Credenza standard without grommets. See page 55 for field-installed grommet option
- Locking pedestals standard and keyed-alike
- Heavy duty full extension ball bearing drawer slides
- Black integral pull standard. For optional silver finish add suffix (/FPS) to product code
- Optional surface-mounted handles available at \$20 each (see page 5)
- Shipped assembled

DOUBLE PEDESTAL CREDENZA - Pedestal Option A

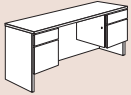

- 2 box/file pedestals

DOUBLE PEDESTAL CREDENZA - Pedestal Option B

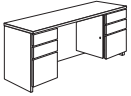

- 2 box/box/file pedestals
- Upper box non-locking

DOUBLE PEDESTAL CREDENZA - Pedestal Option C

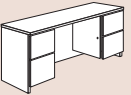

- 2 file/file pedestals

DOUBLE PEDESTAL CREDENZA - Pedestal Option F



- 1 box/box/file pedestal - left
- Upper box non-locking
- 1 file/file pedestal - right

DOUBLE PEDESTAL CREDENZA - Pedestal Option G

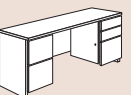

- 1 file/file pedestal - left
- 1 box/box/file pedestal - right
- Upper box non-locking

Product Code	List Price	Dimensions			Wt lbs	Cube ft ³
		W	D	H		
CDP 6020A-H		60	20	29	215	22
CDP 6620A-H		66	20	29	220	24
CDP 7220A-H		72	20	29	230	26
CDP 6024A-H		60	24	29	220	25
CDP 6624A-H		66	24	29	225	27
CDP 7224A-H		72	24	29	235	30
CDP 6020B-H		60	20	29	275	22
CDP 6620B-H		66	20	29	280	24
CDP 7220B-H		72	20	29	290	26
CDP 6024B-H		60	24	29	280	25
CDP 6624B-H		66	24	29	285	27
CDP 7224B-H		72	24	29	295	30
CDP 6020C-H		60	20	29	275	22
CDP 6620C-H		66	20	29	280	24
CDP 7220C-H		72	20	29	290	26
CDP 6024C-H		60	24	29	280	25
CDP 6624C-H		66	24	29	285	27
CDP 7224C-H		72	24	29	295	30
CDP 6020F-H		60	20	29	275	22
CDP 6620F-H		66	20	29	280	24
CDP 7220F-H		72	20	29	290	26
CDP 6024F-H		60	24	29	280	25
CDP 6624F-H		66	24	29	285	27
CDP 7224F-H		72	24	29	295	30
CDP 6020G-H		60	20	29	275	22
CDP 6620G-H		66	20	29	280	24
CDP 7220G-H		72	20	29	290	26
CDP 6024G-H		60	24	29	280	25
CDP 6624G-H		66	24	29	285	27
CDP 7224G-H		72	24	29	295	30

Storage & Lateral File Credenzas

Features:

- 1" thick worksurface
- Full height back panel
- Credenza standard without grommets. See page 55 for field-installed grommet option
- All credenza drawers & doors standard locking and keyed-alike
- Heavy duty full extension ball bearing drawer slides
- Pedestals and lateral files accommodate both letter and legal filing
- "Front-to-back filing" hardware available no charge for lateral files. See page 48
- Black integral pull standard. For optional silver finish add suffix (/FPS) to product code
- Optional surface-mounted handles available at \$20 each (see page 5)
- Shipped assembled



HAVEN

CREDENZA - CENTRE STORAGE & DOUBLE BOX/FILE PEDESTAL

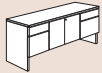

- 2 box/file pedestals
- Centre storage cabinet
- 3 locks keyed alike

CREDENZA - CENTRE STORAGE & DOUBLE BOX/BOX/FILE PEDESTAL

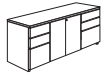

- 2 box/box/file pedestals
- Upper box non-locking
- Centre storage cabinet
- 3 locks keyed alike

CREDENZA - CENTRE STORAGE & DOUBLE FILE/FILE PEDESTAL

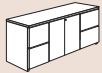

- 2 file/file pedestals
- Centre storage cabinet
- 3 locks keyed alike

CREDENZA - LATERAL FILE LEFT



- 36" wide lateral file

CREDENZA - LATERAL FILE RIGHT

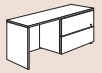

- 36" wide lateral file

CREDENZA - DOUBLE LATERAL FILE

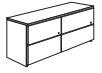

- 30" wide lateral files on 60" credenza
- 36" wide lateral files on 72" credenza

CREDENZA - LATERAL FILE LEFT & STORAGE RIGHT

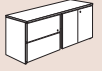

- 36" wide lateral file
- 1 adjustable shelf in storage cabinet

CREDENZA - STORAGE LEFT & LATERAL FILE RIGHT

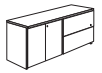

- 36" wide lateral file
- 1 adjustable shelf in storage cabinet

CREDENZA - DOUBLE STORAGE

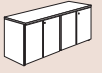

- 1 adjustable shelf left and right

OPTIONS

CUTAWAY END PANEL - RIGHT



- Replaces 20" or 24" right end panel on CFL
- Add suffix (/CGR) to product code

CUTAWAY END PANEL - LEFT

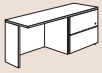

- Replaces 20" or 24" left end panel on CFR
- Add suffix (/CGL) to product code

Product Code	List Price	Dimensions			Wt Cube	
		W	D	H	lbs	ft ³
CZ 6020A-H		60	20	29	210	22
CZ 6620A-H		66	20	29	220	24
CZ 7220A-H		72	20	29	230	26
CZ 6024A-H		60	24	29	230	25
CZ 6624A-H		66	24	29	240	27
CZ 7224A-H		72	24	29	250	30
CZ 6020B-H		60	20	29	270	22
CZ 6620B-H		66	20	29	280	24
CZ 7220B-H		72	20	29	290	26
CZ 6024B-H		60	24	29	290	25
CZ 6624B-H		66	24	29	300	27
CZ 7224B-H		72	24	29	310	30
CZ 6020C-H		60	20	29	270	22
CZ 6620C-H		66	20	29	280	24
CZ 7220C-H		72	20	29	290	26
CZ 6024C-H		60	24	29	290	25
CZ 6624C-H		66	24	29	300	27
CZ 7224C-H		72	24	29	310	30
CFL 6020-H		60	20	29	160	22
CFL 6620-H		66	20	29	170	24
CFL 7220-H		72	20	29	180	26
CFL 6024-H		60	24	29	180	25
CFL 6624-H		66	24	29	190	27
CFL 7224-H		72	24	29	200	30
CFR 6020-H		60	20	29	160	22
CFR 6620-H		66	20	29	170	24
CFR 7220-H		72	20	29	180	26
CFR 6024-H		60	24	29	180	25
CFR 6624-H		66	24	29	190	27
CFR 7224-H		72	24	29	200	30
CFF 6020-H		60	20	29	240	22
CFF 7220-H		72	20	29	260	26
CFF 6024-H		60	24	29	260	25
CFF 7224-H		72	24	29	280	30
CFS 6620-H		66	20	29	240	24
CFS 7220-H		72	20	29	250	26
CFS 6624-H		66	24	29	260	27
CFS 7224-H		72	24	29	270	30
CSF 6620-H		66	20	29	240	24
CSF 7220-H		72	20	29	250	26
CSF 6624-H		66	24	29	260	27
CSF 7224-H		72	24	29	270	30
CSS 6620-H		66	20	29	230	24
CSS 7220-H		72	20	29	240	26
CSS 6624-H		66	24	29	250	27
CSS 7224-H		72	24	29	260	30
/CGR		n/a	n/a	n/a	n/a	n/a
/CGL		n/a	n/a	n/a	n/a	n/a



PROFESSIONAL



Reception Workstations

Features:

- 1" thick work surface
- Desk 30" deep with full height back panel & 2 grommets
- Return 24" deep with 1 grommet centre rear
- Transaction top 12" deep
- Bow Front transaction top 18" deep, with 6" overhang
- 14" clearance above desktop
- Locking pedestal standard
- Heavy duty full extension ball bearing drawer slides
- Black integral pull standard. For optional silver finish add suffix (/FPS) to product code
- Optional surface-mounted handles available at \$20 each (see page 5)
- Shipped assembled - except where noted*



RECEPTION DESK - Pedestal Option A



	Product Code	List Price	Dimensions W D H	Wt lbs	Cube ft ³
Left	GDL 6630A-H		66 30 44	250	55
	GDL 7230A-H		72 30 44	260	60
Right	GDR 6630A-H		66 30 44	250	55
	GDR 7230A-H		72 30 44	260	60

RECEPTION DESK - Pedestal Option B



Left	GDL 6630B-H		66 30 44	280	55
	GDL 7230B-H		72 30 44	290	60
Right	GDR 6630B-H		66 30 44	280	55
	GDR 7230B-H		72 30 44	290	60

RECEPTION DESK - Pedestal Option C

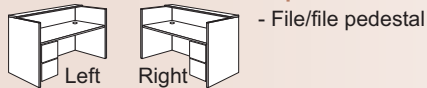

Left	GDL 6630C-H		66 30 44	280	55
	GDL 7230C-H		72 30 44	290	60
Right	GDR 6630C-H		66 30 44	280	55
	GDR 7230C-H		72 30 44	290	60

BOW FRONT RECEPTION DESK - Pedestal Option A

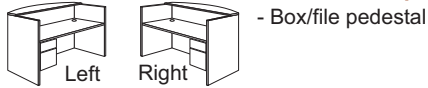

Left	GDBL 6636A-H		66 36 44	260	55
	GDBL 7236A-H		72 36 44	270	60
Right	GDBR 6636A-H		66 36 44	260	55
	GDBR 7236A-H		72 36 44	270	60

BOW FRONT RECEPTION DESK - Pedestal Option B



Left	GDBL 6636B-H		66 36 44	290	55
	GDBL 7236B-H		72 36 44	300	60
Right	GDBR 6636B-H		66 36 44	290	55
	GDBR 7236B-H		72 36 44	300	60

BOW FRONT RECEPTION DESK - Pedestal Option C

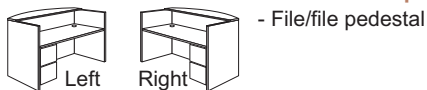

Left	GDBL 6636C-H		66 36 44	290	55
	GDBL 7236C-H		72 36 44	300	60
Right	GDBR 6636C-H		66 36 44	290	55
	GDBR 7236C-H		72 36 44	300	60

RECEPTION RETURN - Pedestal Option A

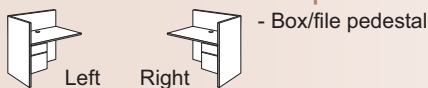

Left	GRL 4224A-H		42 24 43	130	27
	GRL 4824A-H		48 24 43	135	30
Right	GRR 4224A-H		42 24 43	130	27
	GRR 4824A-H		48 24 43	135	30

RECEPTION RETURN - Pedestal Option B



Left	GRL 4224B-H		42 24 43	160	27
	GRL 4824B-H		48 24 43	165	30
Right	GRR 4224B-H		42 24 43	160	27
	GRR 4824B-H		48 24 43	165	30

RECEPTION RETURN - Pedestal Option C

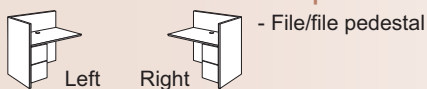

Left	GRL 4224C-H		42 24 43	160	27
	GRL 4824C-H		48 24 43	165	30
Right	GRR 4224C-H		42 24 43	160	27
	GRR 4824C-H		48 24 43	165	30

RECEPTION RETURN - No Pedestal



Left	GRL 4224-H		42 24 43	85	4
	GRL 4824-H		48 24 43	90	4
Right	GRR 4224-H		42 24 43	85	4
	GRR 4824-H		48 24 43	90	4

RECEPTION RETURN - TRANSACTION TOP

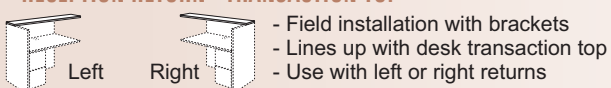

	GRTT 42-H		60 12 1	15	1
	GRTT 48-H		66 12 1	17	1

Corner Units



Features:

- 1" thick worksurface
- Black corner post leg standard. For optional silver finish add suffix (/SL) to product code
- Back panels standard full height with horizontal wood grain pattern
- Optional partial height back panels available (see below)
- Left and right recessed end panels standard
- For keyboard options see page 55

STRAIGHT CORNER

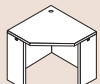

Keyboard Option:

- AKS 22
- AKS 30
- ARK
- DARK

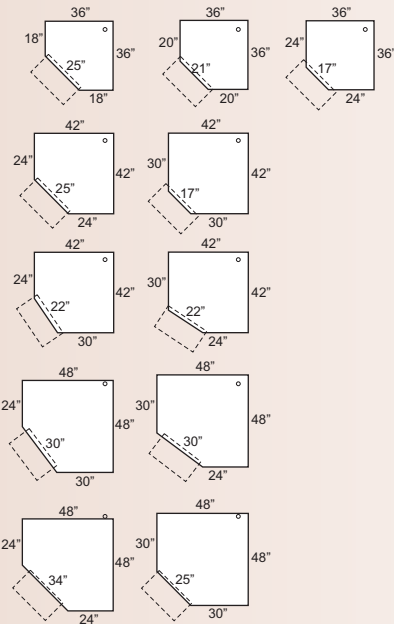

CURVILINEAR CORNER

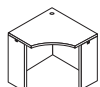

★ = Not intended for keyboard tray

Keyboard Option:

- ARK
- DARK

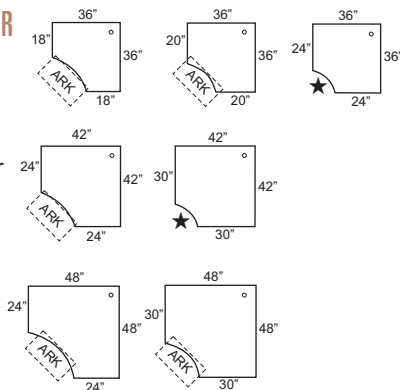

Product Code	List Price	Dimensions W D H	Wt lbs	Cube ft ³	
CC 361818-H		36 36 29	85	3	
CC 362020-H		36 36 29	85	3	
CC 362424-H		36 36 29	85	3	
CC 422424-H		42 42 29	105	4	
CC 423030-H		42 42 29	105	4	
CC 422430-H		42 42 29	105	4	
CC 423024-H		42 42 29	105	4	
CC 482430-H		48 48 29	125	5	
CC 483024-H		48 48 29	125	5	
CC 482424-H		48 48 29	125	5	
CC 483030-H		48 48 29	125	5	
CV 361818-H		36 36 29	85	3	
CV 362020-H		36 36 29	85	3	
CV 362424-H		36 36 29	85	3	
CV 422424-H		42 42 29	105	4	
CV 423030-H		42 42 29	105	4	
CV 482424-H		48 48 29	125	5	
CV 483030-H		48 48 29	125	5	
OPTIONS					
PARTIAL HEIGHT BACK PANELS					
- Choose suffix below to match back panel preference					
- Add suffix to "CDL" or "CDR" product code					
Corner Units:					
(3/4 Height Suffix)	/ 3Q	/ 3QL	/ 3QR		
(1/2 Height Suffix)	/ 2Q	/ 2QL	/ 2QR		
			/ 3Q		
			/ 3QL		
			/ 3QR		
			/ 2Q		
			/ 2QL		
			/ 2QR		
				n/a n/a n/a	-5 n/a
NO-GROMMET OPTION					
			- Add suffix (/NGR) to product code		
	/NGR			n/a n/a n/a	n/a n/a

Specifying Guide - Using Keyboards, Corner Units & Desk Shell Notches

Reference Pages:

- 1" thick worksurface
- Keyboard options - see page 55
- Corner units - see page 27
- Desk shells - see pages 29, 30 and 31
- Optional desk shell notches - see page 32

STRAIGHT CORNERS 36" x 36"

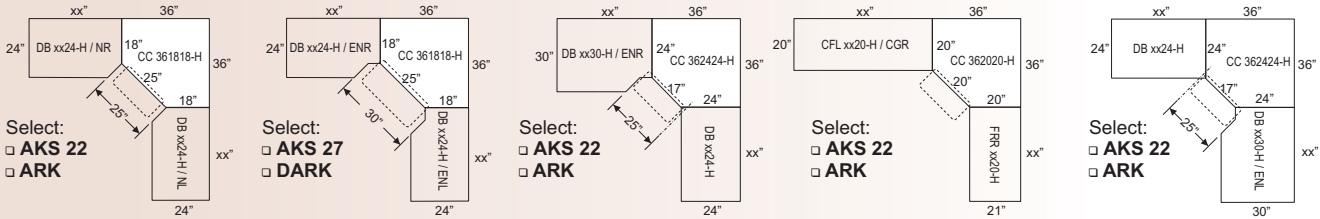

STRAIGHT CORNERS 42" x 42" and 48" x 48"

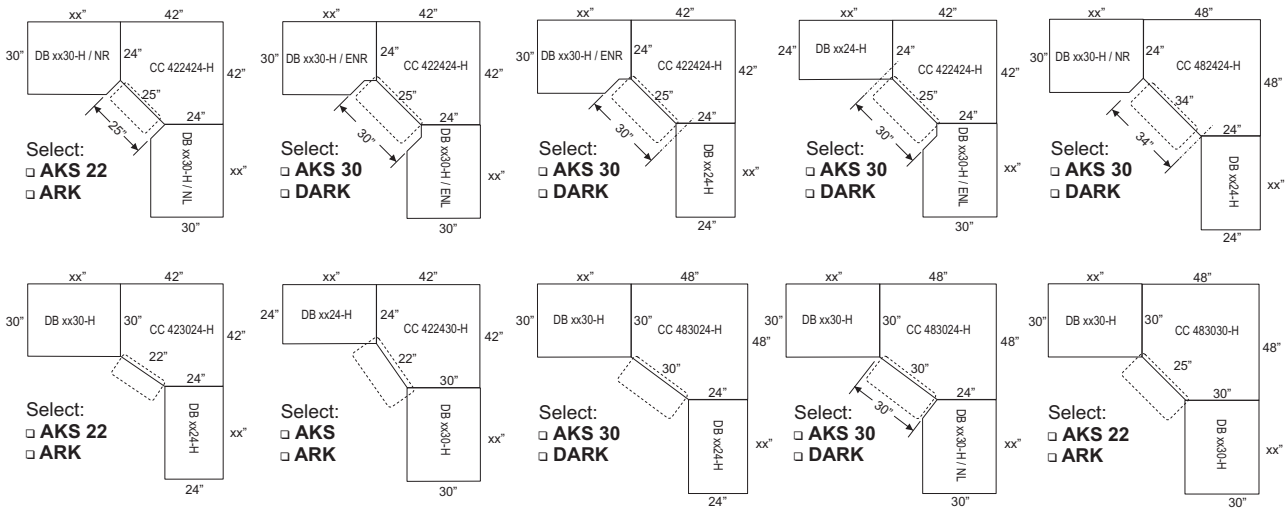

CURVILINEAR CORNERS

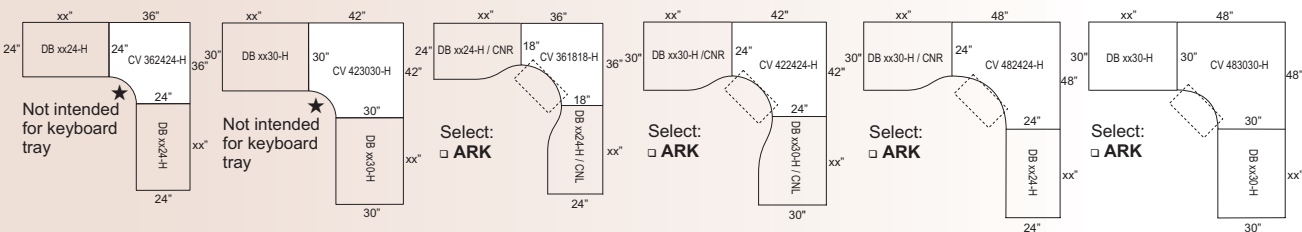

Desk Shells - 20"



Features:

- 1" thick worksurface
- Back panel standard full height with horizontal wood grain pattern
- Optional partial height back panel available (see below)
- Desk shelf available (see page 55)
- Recessed centre support panel included with desk shells 78" or wider
- No-grommet option recommended on 84"w and 96"w desk shells with two 42"w or 48"w overheads meeting in the middle

20" DESK SHELL

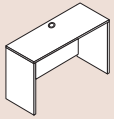

- 2 full end panels

20" DESK SHELL - RIGHT or LEFT

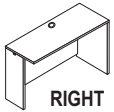

RIGHT

- 1 recessed and 1 full end panel

- May be assembled right hand or left hand by reversing end panels

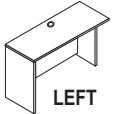

LEFT

20" DESK SHELL BRIDGE

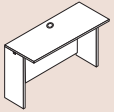

- 2 recessed end panels

OPTIONS

3/4 HEIGHT BACK PANEL



- Add suffix (/ 3Q) to product code
- Provides 8" clearance above the floor

1/2 HEIGHT BACK PANEL



- Add suffix (/ 2Q) to product code
- Provides 14" clearance above the floor

NO-GROMMET OPTION

- Add suffix (/NGR) to product code

Product Code	List Price	Dimensions W D H	Wt lbs	Cube ft ³
DA 2420-H		24 20 29	63	3
DA 3020-H		30 20 29	68	3
DA 3620-H		36 20 29	72	3
DA 4220-H		42 20 29	77	4
DA 4820-H		48 20 29	86	4
DA 5420-H		54 20 29	91	5
DA 6020-H		60 20 29	100	5
DA 6620-H		66 20 29	105	6
DA 7220-H		72 20 29	109	6
DA 7820-H		78 20 29	114	7
DA 8420-H		84 20 29	118	7
DA 9620-H		96 20 29	122	7
DB 2420-H		24 20 29	58	3
DB 3020-H		30 20 29	63	3
DB 3620-H		36 20 29	67	3
DB 4220-H		42 20 29	72	4
DB 4820-H		48 20 29	81	4
DB 5420-H		54 20 29	86	5
DB 6020-H		60 20 29	95	5
DB 6620-H		66 20 29	100	6
DB 7220-H		72 20 29	104	6
DB 7820-H		78 20 29	109	7
DB 8420-H		84 20 29	113	7
DB 9620-H		96 20 29	117	7
DC 2420-H		24 20 29	58	3
DC 3020-H		30 20 29	63	3
DC 3620-H		36 20 29	67	3
DC 4220-H		42 20 29	72	4
DC 4820-H		48 20 29	81	4
DC 5420-H		54 20 29	86	5
DC 6020-H		60 20 29	95	5
DC 6620-H		66 20 29	100	6
DC 7220-H		72 20 29	104	6
DC 7820-H		78 20 29	109	7
DC 8420-H		84 20 29	113	7
DC 9620-H		96 20 29	117	7
/ 3Q		n/a 5/8 20	-3	n/a
/ 2Q		n/a 5/8 14	-5	n/a
/NGR		n/a n/a n/a	n/a	n/a

Desk Shells - 30"



Features:

- 1" thick worksurface
- Back panel standard full height with horizontal wood grain pattern
- Optional partial height back panel available (see below)
- Desk shelf available (see page 55)
- Transition notches available (see page 32)
- Recessed centre support panel included with desk shells 78" or wider
- No-grommet option recommended on 84"w and 96"w desk shells with two 42"w or 48"w overheads meeting in the middle

30" DESK SHELL

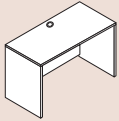

- 2 full end panels

30" DESK SHELL - RIGHT or LEFT

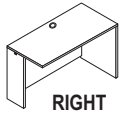

RIGHT

- 1 recessed and 1 full end panel

- May be assembled right hand or left hand by reversing end panels

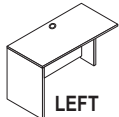

LEFT

30" DESK SHELL BRIDGE

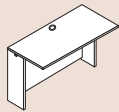

- 2 recessed end panels

OPTIONS

3/4 HEIGHT BACK PANEL

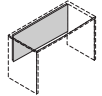

- Add suffix (/ 3Q) to product code
- Provides 8" clearance above the floor

1/2 HEIGHT BACK PANEL

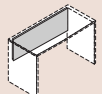

- Add suffix (/ 2Q) to product code
- Provides 14" clearance above the floor

NO-GROMMET OPTION

- Add suffix (/NGR) to product code

Product Code	List Price	Dimensions			Wt Cube	
		W	D	H	lbs	ft ³
DA 2430-H		24	30	29	80	3
DA 3030-H		30	30	29	87	4
DA 3630-H		36	30	29	95	4
DA 4230-H		42	30	29	102	5
DA 4830-H		48	30	29	110	5
DA 5430-H		54	30	29	117	6
DA 6030-H		60	30	29	125	6
DA 6630-H		66	30	29	132	7
DA 7230-H		72	30	29	140	8
DA 7830-H		78	30	29	150	8
DA 8430-H		84	30	29	157	9
DA 9630-H		96	30	29	164	9
DB 2430-H		24	30	29	75	3
DB 3030-H		30	30	29	82	4
DB 3630-H		36	30	29	90	4
DB 4230-H		42	30	29	97	5
DB 4830-H		48	30	29	105	5
DB 5430-H		54	30	29	112	6
DB 6030-H		60	30	29	120	6
DB 6630-H		66	30	29	127	7
DB 7230-H		72	30	29	135	8
DB 7830-H		78	30	29	145	8
DB 8430-H		84	30	29	152	9
DB 9630-H		96	30	29	159	9
DC 2430-H		24	30	29	75	3
DC 3030-H		30	30	29	82	4
DC 3630-H		36	30	29	90	4
DC 4230-H		42	30	29	97	5
DC 4830-H		48	30	29	105	5
DC 5430-H		54	30	29	112	6
DC 6030-H		60	30	29	120	6
DC 6630-H		66	30	29	127	7
DC 7230-H		72	30	29	135	8
DC 7830-H		78	30	29	145	8
DC 8430-H		84	30	29	152	9
DC 9630-H		96	30	29	159	9
/ 3Q		n/a	5/8	20	-3	n/a
/ 2Q		n/a	5/8	14	-5	n/a
/NGR		n/a	n/a	n/a	n/a	n/a

Desk Shells - Inset Back Panel

Features:

- 1" thick worksurface
- Full height inset back panel standard; with horizontal wood grain pattern
- Back inset 6" for 30" desks, 12" for 36" desks
- Standard without grommets. See page 55 for field-installed grommet option
- Recessed centre support panel included with desk shells 78" or wider

Optional Desk Shell Notches

Features:

- Notches enable transition from 30" deep surface to adjacent 24" deep surface, or transition from 24" deep surface to adjacent 18" deep surface
- Notches are not available for 20" deep desk shells and inset back panel desk shells
- For transition notch applications see page 32

DESK SHELL - INSET BACK PANEL

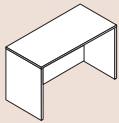

- 2 full end panels

DESK SHELL - RIGHT or LEFT - INSET BACK PANEL

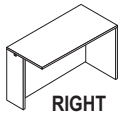

- 1 recessed and 1 full end panel

- May be assembled right hand or left hand by reversing end panels

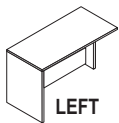

LEFT

OPTIONAL DESK SHELL NOTCHES

TRANSITION NOTCH RIGHT - DESK SHELL LEFT

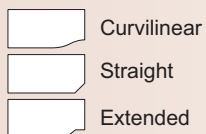
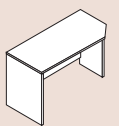

- Add suffix to desk shell product code
- When adding a pedestal, refer to notch dimensions below

TRANSITION NOTCH LEFT - DESK SHELL RIGHT

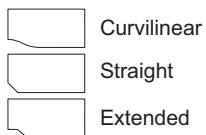
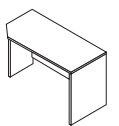

- Add suffix to desk shell product code
- When adding a pedestal, refer to notch dimensions below

Product Code	List Price	Dimensions			Wt Cube	
		W	D	H	lbs	ft ³
DAI 2430-H		24	30	29	80	3
DAI 3030-H		30	30	29	87	4
DAI 3630-H		36	30	29	95	4
DAI 4230-H		42	30	29	102	5
DAI 4830-H		48	30	29	110	5
DAI 5430-H		54	30	29	117	6
DAI 6030-H		60	30	29	125	6
DAI 6630-H		66	30	29	132	7
DAI 7230-H		72	30	29	140	8
DAI 7830-H		78	30	29	150	8
DAI 8430-H		84	30	29	157	9
DAI 9630-H		96	30	29	164	9
DAI 6036-H		60	36	29	135	9
DAI 6636-H		66	36	29	142	10
DAI 7236-H		72	36	29	150	11
DBI 2430-H		24	30	29	75	3
DBI 3030-H		30	30	29	82	4
DBI 3630-H		36	30	29	90	4
DBI 4230-H		42	30	29	97	5
DBI 4830-H		48	30	29	105	5
DBI 5430-H		54	30	29	112	6
DBI 6030-H		60	30	29	120	6
DBI 6630-H		66	30	29	127	7
DBI 7230-H		72	30	29	135	8
DBI 7830-H		78	30	29	145	8
DBI 8430-H		84	30	29	152	9
DBI 9630-H		96	30	29	159	9
DBI 6036-H		60	36	29	130	9
DBI 6636-H		66	36	29	137	10
DBI 7236-H		72	36	29	145	11
/ CNR		n/a	n/a	n/a	n/a	n/a
/ NR		n/a	n/a	n/a	n/a	n/a
/ ENR		n/a	n/a	n/a	n/a	n/a
/ CNL		n/a	n/a	n/a	n/a	n/a
/ NL		n/a	n/a	n/a	n/a	n/a
/ ENL		n/a	n/a	n/a	n/a	n/a

SPECIFICATIONS

Diagrams show Right Hand notches. Left Hand are opposite.

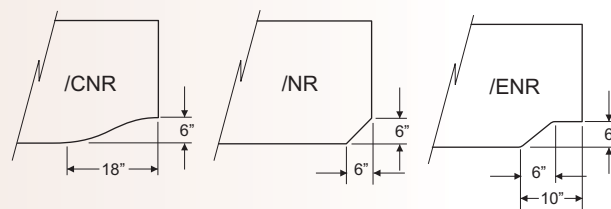















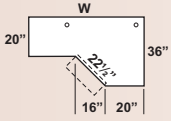

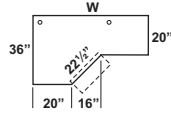

FLEXIBLE

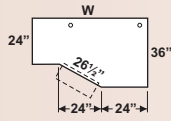

Extended Corner Desk Shells

Features:

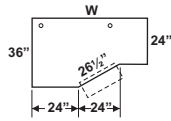
- 1" thick worksurface
- Black corner post leg standard. For optional silver finish add suffix (/SL) to product code
- Back panels standard full height with horizontal wood grain pattern
- Optional partial height back panel available (see page 35)
- Optional curved cutaway in worksurface (see page 35)
- 6024 desk shells do not accommodate optional pedestal

	Product Code	List Price	Dimensions			Wt Cube	
			W	D	H	lbs	ft ³
 <p>2 full end panels</p>	CDLA 6020-H		60	36	29	115	5
	CDLA 6620-H		66	36	29	125	6
	CDLA 7220-H		72	36	29	135	7
  <p>1 full end panel and 1 recessed end panel - interchangeable</p>	CDLB 6020-H		60	36	29	115	5
	CDLB 6620-H		66	36	29	125	6
	CDLB 7220-H		72	36	29	135	7
 <p>2 recessed end panels</p>	CDLC 6020-H		60	36	29	115	5
	CDLC 6620-H		66	36	29	125	6
	CDLC 7220-H		72	36	29	135	7
 <p>2 full end panels</p>	CDRA 6020-H		60	36	29	115	5
	CDRA 6620-H		66	36	29	125	6
	CDRA 7220-H		72	36	29	135	7
  <p>1 full end panel and 1 recessed end panel - interchangeable</p>	CDRB 6020-H		60	36	29	115	5
	CDRB 6620-H		66	36	29	125	6
	CDRB 7220-H		72	36	29	135	7
 <p>2 recessed end panels</p>	CDRC 6020-H		60	36	29	115	5
	CDRC 6620-H		66	36	29	125	6
	CDRC 7220-H		72	36	29	135	7
 <p>2 full end panels</p>	CDLA 6024-H		60	36	29	115	5
	CDLA 6624-H		66	36	29	125	6
	CDLA 7224-H		72	36	29	135	7
  <p>1 full end panel and 1 recessed end panel - interchangeable</p>	CDLB 6024-H		60	36	29	115	5
	CDLB 6624-H		66	36	29	125	6
	CDLB 7224-H		72	36	29	135	7
 <p>2 recessed end panels</p>	CDLC 6024-H		60	36	29	115	5
	CDLC 6624-H		66	36	29	125	6
	CDLC 7224-H		72	36	29	135	7
 <p>2 full end panels</p>	CDRA 6024-H		60	36	29	115	5
	CDRA 6624-H		66	36	29	125	6
	CDRA 7224-H		72	36	29	135	7
  <p>1 full end panel and 1 recessed end panel - interchangeable</p>	CDRB 6024-H		60	36	29	115	5
	CDRB 6624-H		66	36	29	125	6
	CDRB 7224-H		72	36	29	135	7
 <p>2 recessed end panels</p>	CDRC 6024-H		60	36	29	115	5
	CDRC 6624-H		66	36	29	125	6
	CDRC 7224-H		72	36	29	135	7
NO-GROMMET OPTION							
- Add suffix (/NGR) to product code	/NGR		n/a	n/a	n/a	n/a	n/a



Extended Corner Desk Shells



Features:

- 1" thick worksurface
- Black corner post leg standard. For optional silver finish add suffix (/SL) to product code
- Back panels standard full height with horizontal wood grain pattern
- Optional partial height back panels available (see below)
- Optional curved cutaway in worksurface (see below)
- 6030 and 6630 desk shells do not accommodate optional pedestal

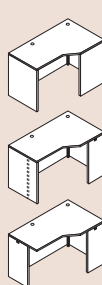
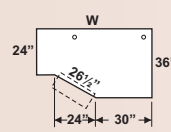
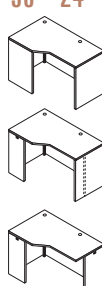
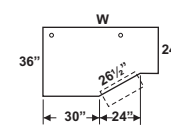
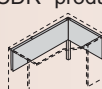
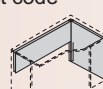
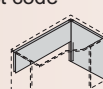
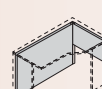
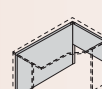
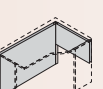
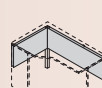
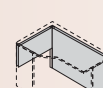
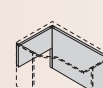
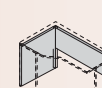
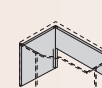
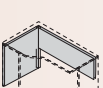
HAVEN

	Product Code	List Price	Dimensions W D H	Wt lbs	Cube ft ³
24" - 30" CORNER DESK SHELL - EXTENDED LEFT  <div style="display: flex; align-items: center;">  <div style="margin-left: 20px;"> <p>2 full end panels</p> <hr/> <p>1 full end panel and 1 recessed end panel - interchangeable</p> <hr/> <p>2 recessed end panels</p> </div> </div>	CDLA 6030-H		60 36 29	115	5
	CDLA 6630-H		66 36 29	125	6
	CDLA 7230-H		72 36 29	135	7
	CDLB 6030-H		60 36 29	115	5
	CDLB 6630-H		66 36 29	125	6
	CDLB 7230-H		72 36 29	135	7
	CDLC 6030-H		60 36 29	115	5
	CDLC 6630-H		66 36 29	125	6
	CDLC 7230-H		72 36 29	135	7
30" - 24" CORNER DESK SHELL - EXTENDED RIGHT  <div style="display: flex; align-items: center;">  <div style="margin-left: 20px;"> <p>2 full end panels</p> <hr/> <p>1 full end panel and 1 recessed end panel - interchangeable</p> <hr/> <p>2 recessed end panels</p> </div> </div>	CDRA 6030-H		60 36 29	115	5
	CDRA 6630-H		66 36 29	125	6
	CDRA 7230-H		72 36 29	135	7
	CDRB 6030-H		60 36 29	115	5
	CDRB 6630-H		66 36 29	125	6
	CDRB 7230-H		72 36 29	135	7
	CDRC 6030-H		60 36 29	115	5
	CDRC 6630-H		66 36 29	125	6
	CDRC 7230-H		72 36 29	135	7
OPTIONS PARTIAL HEIGHT BACK PANELS - Choose suffix below to match back panel preference - Add suffix to "CDL" or "CDR" product code "CDL" Corner Desk Shells: <div style="display: flex; justify-content: space-around; align-items: flex-start; margin-top: 10px;"> <div style="text-align: center;">  (3/4 Height Suffix) / 3Q </div> <div style="text-align: center;">  (1/2 Height Suffix) / 2Q </div> <div style="text-align: center;">  / 3QL </div> <div style="text-align: center;">  / 2QL </div> <div style="text-align: center;">  / 3QR </div> <div style="text-align: center;">  / 2QR </div> </div> "CDR" Corner Desk Shells: <div style="display: flex; justify-content: space-around; align-items: flex-start; margin-top: 10px;"> <div style="text-align: center;">  (3/4 Height Suffix) / 3Q </div> <div style="text-align: center;">  (1/2 Height Suffix) / 2Q </div> <div style="text-align: center;">  / 3QL </div> <div style="text-align: center;">  / 2QL </div> <div style="text-align: center;">  / 3QR </div> <div style="text-align: center;">  / 2QR </div> </div>	/ 3Q / 3QL / 3QR / 2Q / 2QL / 2QR		n/a n/a n/a	-5	n/a
	CURVED CUTAWAY - Add suffix (/CV) to product code - Replaces straight cutaway in worksurface <div style="display: flex; justify-content: center; align-items: center; margin-top: 10px;">  LEFT  RIGHT </div>	/ CV		n/a n/a n/a	n/a
NO-GROMMET OPTION - Add suffix (/NGR) to product code	/NGR		n/a n/a n/a	n/a	n/a

D-Tops

Features:

- 1" thick worksurface
- 6" diameter black post leg standard. For optional silver finish add suffix (/SL) to product code
- Suspended D-Tops have no grommet
- Freestanding D-Tops must be attached to adjacent furniture for proper stability

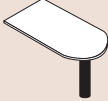
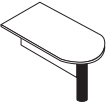
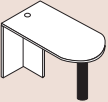
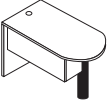
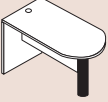
	Product Code	List Price	Dimensions			Wt lbs	Cube ft ³	
			W	D	H			
SUSPENDED 	DS 3624-H		36	24	29	60	2	
	DS 4224-H		42	24	29	65	2	
	DS 4824-H		48	24	29	70	3	
	DS 5424-H		54	24	29	75	3	
	DS 6024-H		60	24	29	80	4	
	DS 6624-H		66	24	29	85	4	
	DS 4830-H		48	30	29	80	3	
	DS 5430-H		54	30	29	85	3	
	DS 6030-H		60	30	29	90	4	
	DS 6630-H		66	30	29	93	4	
	DS 7230-H		72	30	29	95	5	
	DS 6636-H		66	36	29	95	5	
	DS 7236-H		72	36	29	100	5	
	SUSPENDED - with centered 14" high modesty panel 	DSM 3624-H		36	24	29	75	2
		DSM 4224-H		42	24	29	80	2
DSM 4824-H			48	24	29	85	3	
DSM 5424-H			54	24	29	90	3	
DSM 6024-H			60	24	29	95	4	
DSM 6624-H			66	24	29	100	4	
DSM 4830-H			48	30	29	95	3	
DSM 5430-H			54	30	29	100	3	
DSM 6030-H			60	30	29	105	4	
DSM 6630-H			66	30	29	108	4	
DSM 7230-H			72	30	29	110	5	
DSM 6636-H			66	36	29	110	5	
DSM 7236-H			72	36	29	115	5	
		For full-height modesty panel, add suffix (/FMP) to product code.						
FREE STANDING 		DF 4824-H		48	24	29	85	4
	DF 5424-H		54	24	29	95	4	
	DF 6024-H		60	24	29	105	4	
	DF 6624-H		66	24	29	115	5	
	DF 4830-H		48	30	29	110	5	
	DF 5430-H		54	30	29	115	5	
	DF 6030-H		60	30	29	120	5	
	DF 6630-H		66	30	29	125	5	
	DF 7230-H		72	30	29	130	6	
	DF 6636-H		66	36	29	130	6	
	DF 7236-H		72	36	29	135	6	
	FREE STANDING - with reversible, offset 14" high modesty panel 	DM 6030-H		60	30	29	125	5
		DM 6630-H		66	30	29	130	5
DM 7230-H			72	30	29	135	6	
DM 7236-H			72	36	29	135	6	
FREE STANDING - with centred 14" high modesty panel 		DCM 4824-H		48	24	29	85	4
	DCM 5424-H		54	24	29	95	4	
	DCM 6024-H		60	24	29	105	4	
	DCM 6624-H		66	24	29	115	5	
	DCM 4830-H		48	30	29	110	5	
	DCM 5430-H		54	30	29	115	5	
	DCM 6030-H		60	30	29	120	5	
	DCM 6630-H		66	30	29	125	5	
	DCM 7230-H		72	30	29	130	6	
	DCM 6636-H		66	36	29	130	6	
	DCM 7236-H		72	36	29	135	6	
		For full-height modesty panel, add suffix (/FMP) to product code.						



COLLABORATIVE

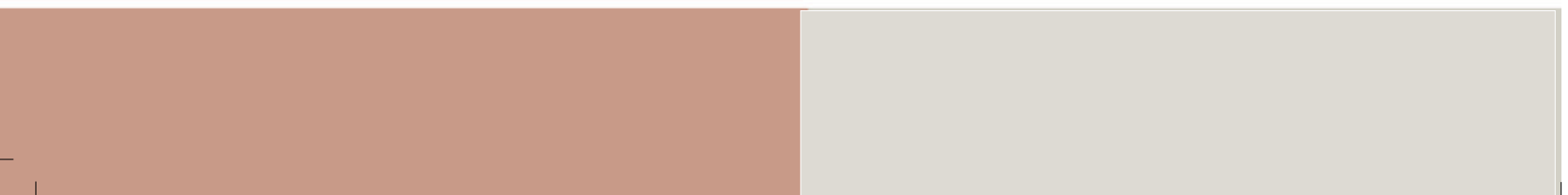

P-Tops

Features:

- 1" thick worksurface
- 6" diameter black post leg standard. For optional silver finish add suffix (/SL) to product code
- Suspended P-Tops have no grommet
- Freestanding P-Tops must be attached to adjacent furniture for proper stability



HAVEN

SUSPENDED - Left Hand

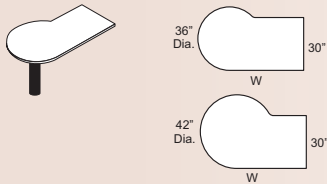

SUSPENDED - Right Hand

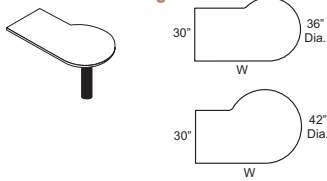

FREE STANDING - Left Hand

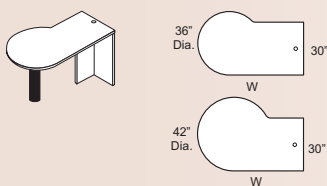

FREE STANDING - Right Hand

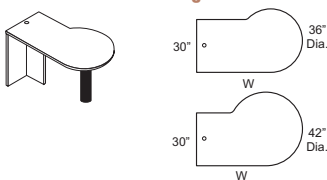

FREE STANDING - Left Hand with 14" high modesty panel

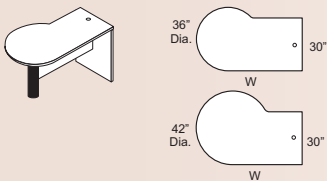

For full-height modesty panel, add suffix (/FMP) to product code.

FREE STANDING - Right Hand with 14" high modesty panel

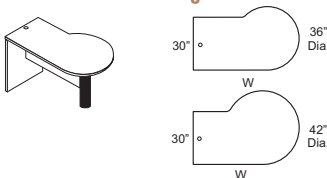

For full-height modesty panel, add suffix (/FMP) to product code.

Product Code	List Price	Dimensions			Wt Cube	
		W	D	H	lbs	ft ³
PLS 6036-H		60	36	29	85	4
PLS 6636-H		66	36	29	90	5
PLS 7236-H		72	36	29	95	5
PLS 6042-H		60	42	29	88	4
PLS 6642-H		66	42	29	93	5
PLS 7242-H		72	42	29	98	5
PRs 6036-H		60	36	29	85	4
PRs 6636-H		66	36	29	90	5
PRs 7236-H		72	36	29	95	5
PRs 6042-H		60	42	29	88	4
PRs 6642-H		66	42	29	93	5
PRs 7242-H		72	42	29	98	5
PLF 6036-H		60	36	29	115	5
PLF 6636-H		66	36	29	125	5
PLF 7236-H		72	36	29	130	5
PLF 6042-H		60	42	29	120	6
PLF 6642-H		66	42	29	130	6
PLF 7242-H		72	42	29	135	6
PRF 6036-H		60	36	29	115	5
PRF 6636-H		66	36	29	125	6
PRF 7236-H		72	36	29	130	6
PRF 6042-H		60	42	29	120	5
PRF 6642-H		66	42	29	130	6
PRF 7242-H		72	42	29	135	6
PLM 6036-H		60	36	29	115	5
PLM 6636-H		66	36	29	125	6
PLM 7236-H		72	36	29	130	6
PLM 6042-H		60	42	29	120	5
PLM 6642-H		66	42	29	130	6
PLM 7242-H		72	42	29	135	6
PRM 6036-H		60	36	29	115	5
PRM 6636-H		66	36	29	125	6
PRM 7236-H		72	36	29	130	6
PRM 6042-H		60	42	29	120	5
PRM 6642-H		66	42	29	130	6
PRM 7242-H		72	42	29	135	6



Overheads - 36" and 43" High

Features:

- 1" thick top
- 13¾" internal height clearance
- Full width concealed cable pass-thru 1¾" high
- 36" overheads have 17½" clearance above desktop and 65" installed height
- 43" overheads have 24" clearance above desktop and 72" installed height
- For cutaway gable options see page 41
- Closed overheads standard without handles and non-locking. For lock options see below
- Shipped assembled

		Product Code	List Price	Dimensions			Wt	Cube
				W	D	H	lbs	ft ³
OPEN OVERHEAD - 36" HIGH								
	without centre divider	OS 2436-H		24	16	36	60	9
		OS 3036-H		30	16	36	70	10
	with centre divider	OS 3636-H		36	16	36	80	12
		OS 4236-H		42	16	36	90	14
		OS 4836-H		48	16	36	100	16
		OS 5436-H		54	16	36	110	18
		OS 6036-H		60	16	36	120	20
		OS 6636-H		66	16	36	130	21
		OS 7236-H		72	16	36	140	23
		OS 7836-H		78	16	36	150	24
OPEN OVERHEAD - 43" HIGH								
	without centre divider	OS 2443-H		24	16	43	60	10
		OS 3043-H		30	16	43	70	11
	with centre divider	OS 3643-H		36	16	43	80	13
		OS 4243-H		42	16	43	90	15
		OS 4843-H		48	16	43	100	18
		OS 5443-H		54	16	43	110	20
		OS 6043-H		60	16	43	120	22
		OS 6643-H		66	16	43	130	23
		OS 7243-H		72	16	43	140	26
		OS 7843-H		78	16	43	150	27
CLOSED OVERHEAD - 36" HIGH								
	2 doors	OD 2436-H		24	16	36	70	9
		OD 3036-H		30	16	36	80	10
		OD 3636-H		36	16	36	95	12
		OD 4236-H		42	16	36	105	14
	3 doors	OD 4836-H		48	16	36	120	16
		OD 5436-H		54	16	36	130	18
	4 doors	OD 6036-H		60	16	36	145	20
		OD 6636-H		66	16	36	155	21
		OD 7236-H		72	16	36	170	23
		OD 7836-H		78	16	36	180	24
		Lock Option - add suffix (/L) to product code						
CLOSED OVERHEAD - 43" HIGH								
	2 doors	OD 2443-H		24	16	43	80	10
		OD 3043-H		30	16	43	90	11
		OD 3643-H		36	16	43	105	13
		OD 4243-H		42	16	43	115	15
	3 doors	OD 4843-H		48	16	43	130	18
		OD 5443-H		54	16	43	140	20
	4 doors	OD 6043-H		60	16	43	155	22
		OD 6643-H		66	16	43	165	23
		OD 7243-H		72	16	43	180	26
		OD 7843-H		78	16	43	190	27
		Lock Option - add suffix (/L) to product code						

Overheads - Frosted Glass Doors and Sliding Frosted Acrylic Doors

Features:

- 1" thick top
- 13¾" internal height clearance
- For cutaway gable options see page 41
- Closed overheads standard without handles and non-locking.
- Full width concealed cable pass-thru 1¾" high on 36" and 43" high units
- Shipped assembled



EXECUTIVE OVERHEAD - FROSTED GLASS DOORS

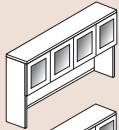

- 36" high
- 17½" clearance above desktop
- Not available locking

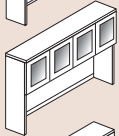

- 43" high
- 24" clearance above desktop
- Not available locking

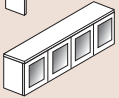

- Wall-mount instructions and hardware included
- Not available locking

NOTE: Door Frame Available in Aluminum Finish only

OVERHEAD - 36" HIGH - SLIDING FROSTED ACRYLIC DOORS

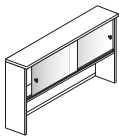

- 36" high
- 17½" clearance above desktop
- Not available locking

OVERHEAD - 43" HIGH - SLIDING FROSTED ACRYLIC DOORS

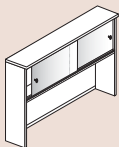

- 43" high
- 24" clearance above desktop
- Not available locking

WALL-MOUNT OVERHEAD - SLIDING FROSTED ACRYLIC DOORS

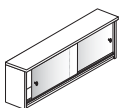





- Wall-mount instructions and hardware included
- Not available locking

Product Code	List Price	Dimensions			Wt lbs	Cube ft ³
		W	D	H		
OF 6036-H /AL		60	16	36	145	19
OF 6636-H /AL		66	16	36	155	21
OF 7236-H /AL		72	16	36	170	23
OF 6043-H /AL		60	16	43	155	21
OF 6643-H /AL		66	16	43	165	23
OF 7243-H /AL		72	16	43	180	26
WMOF 60-H /AL		60	17	18	118	13
WMOF 66-H /AL		66	17	18	129	14
WMOF 72-H /AL		72	17	18	140	15
OSD 4236-H		42	16	36	120	14
OSD 4836-H		48	16	36	135	16
OSD 5436-H		54	16	36	145	18
OSD 6036-H		60	16	36	160	20
OSD 6636-H		66	16	36	175	21
OSD 7236-H		72	16	36	190	23
OSD 7836-H		78	16	36	195	24
OSD 4243-H		42	16	43	130	15
OSD 4843-H		48	16	43	145	18
OSD 5443-H		54	16	43	155	20
OSD 6043-H		60	16	43	170	22
OSD 6643-H		66	16	43	185	23
OSD 7243-H		72	16	43	195	26
OSD 7843-H		78	16	43	205	27
WMOSD 42-H		42	17	18	93	9
WMOSD 48-H		48	17	18	111	10
WMOSD 54-H		54	17	18	122	11
WMOSD 60-H		60	17	18	133	13
WMOSD 66-H		66	17	18	144	14
WMOSD 72-H		72	17	18	155	15
WMOSD 78-H		78	17	18	166	16

Overheads - Wall-Mount and Cutaway Gable Options

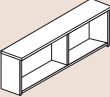
Features:

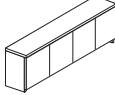
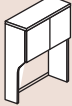
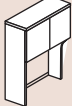
- 1" thick top
- 13¾" internal height clearance
- Closed overheads standard without handles and non-locking.
- Lock option available for wall-mount (see below)
- Shipped assembled

		Product Code	List Price	Dimensions W D H	Wt lbs	Cube ft ³
WALL-MOUNT OVERHEAD - OPEN						
	without centre divider	WMOS 24-H		24 17 18	42	5
		WMOS 30-H		30 17 18	51	6
	with centre divider	WMOS 36-H		36 17 18	59	8
		WMOS 42-H		42 17 18	68	9
		WMOS 48-H		48 17 18	76	10
		WMOS 54-H		54 17 18	85	11
		WMOS 60-H		60 17 18	93	13
		WMOS 66-H		66 17 18	102	14
- Wall-mount hardware and instructions included		WMOS 72-H		72 17 18	110	15
		WMOS 78-H		78 17 18	119	16
WALL-MOUNT OVERHEAD - CLOSED						
	2 doors	WMOD 24-H		24 17 18	52	5
		WMOD 30-H		30 17 18	61	6
		WMOD 36-H		36 17 18	72	8
		WMOD 42-H		42 17 18	83	9
	3 doors	WMOD 48-H		48 17 18	96	10
		WMOD 54-H		54 17 18	107	11
	4 doors	WMOD 60-H		60 17 18	118	13
		WMOD 66-H		66 17 18	129	14
		WMOD 72-H		72 17 18	140	15
		WMOD 78-H		78 17 18	151	16
Lock Option - add suffix (/L) to product code						
OPTIONS: For all 36" High and 43" High Overheads						
CUTAWAY GABLE - LEFT						
	- Add suffix (/CGL) to product code	/CGL		n/a n/a n/a	n/a n/a	
	- 6" cutaway					
CUTAWAY GABLE - RIGHT						
	- Add suffix (/CGR) to product code	/CGR		n/a n/a n/a	n/a n/a	
	- 6" cutaway					
CUTAWAY GABLE - LEFT & RIGHT						
	- Add suffix (/CGL /CGR) to product code	/CGL /CGR		n/a n/a n/a	n/a n/a	
	- 6" cutaway					

NOTES:

- Cutaway Gable option is not designed for stand-alone overhead application or overhead with paper sorter insert
- Specify No-grommet option on a desk shell if you position two overheads on top and they meet in the middle of the desk

Corner Overheads - 36" and 43" High

Features:

- 1" thick top
- 13¾" internal height clearance
- Full width concealed cable pass-thru 1¾" high
- 36" overheads have 17½" clearance above desktop and 65" installed height
- 43" overheads have 24" clearance above desktop and 72" installed height
- For cutaway gable options see page 41
- Corner overheads with doors are non-locking only; standard without handles
- Shipped assembled in 2 cartons

OPEN CORNER OVERHEAD - 36" HIGH

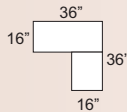
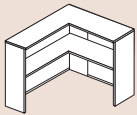

Product Code

List Price

Dimensions
W W D H

Wt lbs
Cube ft³

OCS 3636-H

36 36 36

140 24

OPEN CORNER OVERHEAD - 36" HIGH

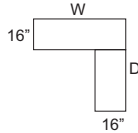
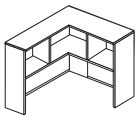

OCS 4236-H

42 42 36

150 26

OCS 4836-H

48 48 36

160 28

OPEN CORNER OVERHEAD - 43" HIGH

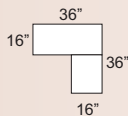
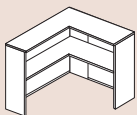

OCS 3643-H

36 36 43

160 25

OPEN CORNER OVERHEAD - 43" HIGH

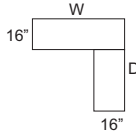
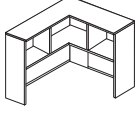

OCS 4243-H

42 42 43

170 27

OCS 4843-H

48 48 43

180 29

CLOSED CORNER OVERHEAD - 36" HIGH

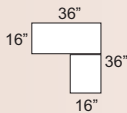
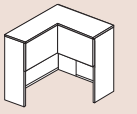

2 doors

OCD 3636-H

36 36 36

165 24

CLOSED CORNER OVERHEAD - 36" HIGH

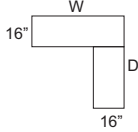
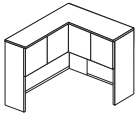

4 doors

OCD 4236-H

42 42 36

175 26

OCD 4836-H

48 48 36

190 28

CLOSED CORNER OVERHEAD - 43" HIGH

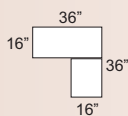
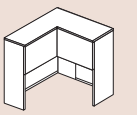

2 doors

OCD 3643-H

36 36 43

185 25

CLOSED CORNER OVERHEAD - 43" HIGH

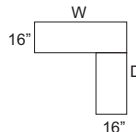
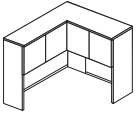

4 doors

OCD 4243-H

42 42 43

195 27

OCD 4843-H

48 48 43

210 29

HAVEN

Paper Management Options



HAVEN

STACK-ON ORGANIZER HUTCH

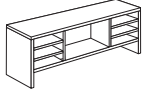

Product Code	List Price	Dimensions	Wt lbs	Cube ft ³
SOH 6022-H		60 16 22	105	15
SOH 6622-H		66 16 22	112	17
SOH 7222-H		72 16 22	120	18
SOH 7822-H		78 16 22	129	19

PAPER ORGANIZER



- Horizontal Dividers

POHD 1713-H

17 13½ 17¼

30 3

PAPER ORGANIZER



- Horizontal and Vertical Dividers

POHVD 1713-H

17 13½ 17¼

31 3

OVERHEAD PAPER SORTER INSERT

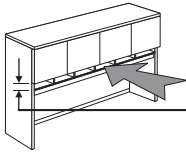

- Field installed
- Not available for Corner Overheads and Wall-Mount Overheads, or with cutaway gable

2½" clearance below doors
(4½" below shelf)

OPS 24-H		22 13½ 5¼	14	2
OPS 30-H		28 13½ 5¼	17	2
OPS 36-H		34 13½ 5¼	20	2
OPS 42-H		40 13½ 5¼	23	2
OPS 48-H		46 13½ 5¼	26	2
OPS 54-H		52 13½ 5¼	29	2
OPS 60-H		58 13½ 5¼	32	2
OPS 66-H		64 13½ 5¼	35	2
OPS 72-H		70 13½ 5¼	38	2
OPS 78-H		76 13½ 5¼	41	2

Reception Galleries

Features:

- 1" thick top
- Laminate back panel standard
- Transaction top 12" deep
- Bow front transaction top 18" deep, with 6" overhang
- Installed height 44"
- Clearance above desk top is 14"

RECEPTION GALLERY

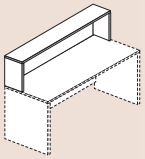

Product Code	List Price	Dimensions			Wt lbs	Cube ft ³
		W	D	H		
OSG 24-H		24	12	15	30	2
OSG 30-H		30	12	15	35	3
OSG 36-H		36	12	15	40	3
OSG 42-H		42	12	15	45	4
OSG 48-H		48	12	15	50	4
OSG 54-H		54	12	15	55	5
OSG 60-H		60	12	15	60	5
OSG 66-H		66	12	15	65	6
OSG 72-H		72	12	15	70	6
OSG 78-H		78	12	15	75	7
OSG 84-H		84	12	15	80	7
OSG 96-H		96	12	15	90	8

BOW FRONT RECEPTION GALLERY

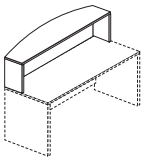

BOSG 24-H		24	18	15	35	3
BOSG 30-H		30	18	15	40	4
BOSG 36-H		36	18	15	45	5
BOSG 42-H		42	18	15	50	6
BOSG 48-H		48	18	15	55	6
BOSG 54-H		54	18	15	60	7
BOSG 60-H		60	18	15	65	8
BOSG 66-H		66	18	15	70	9
BOSG 72-H		72	18	15	75	10
BOSG 78-H		78	18	15	80	10
BOSG 84-H		84	18	15	85	11
BOSG 96-H		96	18	15	95	12

CORNER RECEPTION GALLERY - 36" x 36"

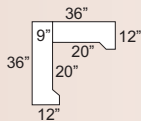
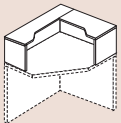

OSGC 36-H		36	36	15	45	3
-----------	--	----	----	----	----	---

CORNER RECEPTION GALLERY - 42" x 42"

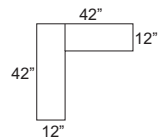
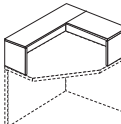

OSGC 42-H		42	42	15	55	4
-----------	--	----	----	----	----	---

CORNER RECEPTION GALLERY - 48" x 48"

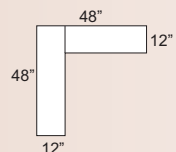
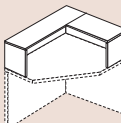

OSGC 48-H		48	48	15	65	4
-----------	--	----	----	----	----	---

Extended Corner Reception Galleries

Features:

- 1" thick top
- Laminate back panel standard
- Installed height is 44"
- Clearance above desk top is 14"

24" CORNER RECEPTION GALLERY - LEFT

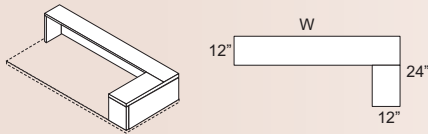

24" CORNER RECEPTION GALLERY - RIGHT

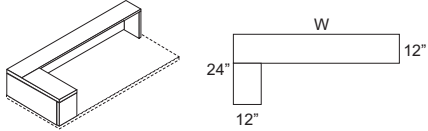

30" CORNER RECEPTION GALLERY - LEFT

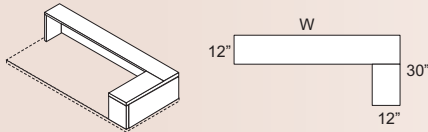

30" CORNER RECEPTION GALLERY - RIGHT

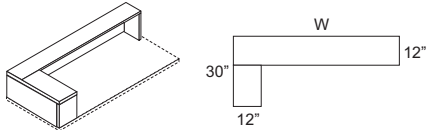

36" CORNER RECEPTION GALLERY - LEFT

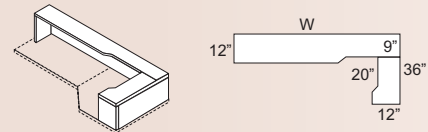

36" CORNER RECEPTION GALLERY - RIGHT

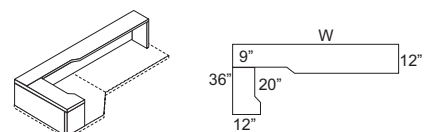

42" CORNER RECEPTION GALLERY - LEFT

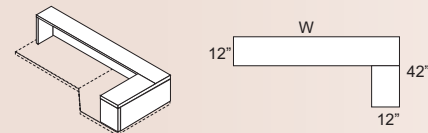

42" CORNER RECEPTION GALLERY - RIGHT

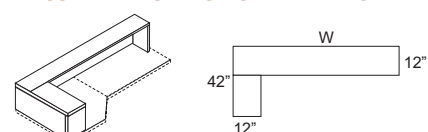

Product Code	List Price	Dimensions			Wt Cube	
		W	D	H	lbs	ft ³
OSGCL 6024-H		60	24	15	70	2
OSGCL 6624-H		66	24	15	75	2
OSGCL 7224-H		72	24	15	80	3
OSGCL 8424-H		84	24	15	90	3
OSGCL 9624-H		96	24	15	100	3
OSGCR 6024-H		60	24	15	70	2
OSGCR 6624-H		66	24	15	75	2
OSGCR 7224-H		72	24	15	80	3
OSGCR 8424-H		84	24	15	90	3
OSGCR 9624-H		96	24	15	100	3
OSGCL 6030-H		60	30	15	75	2
OSGCL 6630-H		66	30	15	80	3
OSGCL 7230-H		72	30	15	85	3
OSGCL 8430-H		84	30	15	95	3
OSGCL 9630-H		96	30	15	105	4
OSGCR 6030-H		60	30	15	75	2
OSGCR 6630-H		66	30	15	80	3
OSGCR 7230-H		72	30	15	85	3
OSGCR 8430-H		84	30	15	95	3
OSGCR 9630-H		96	30	15	105	4
OSGCL 6036-H		60	36	15	80	3
OSGCL 6636-H		66	36	15	85	3
OSGCL 7236-H		72	36	15	90	3
OSGCL 8436-H		84	36	15	100	4
OSGCL 9636-H		96	36	15	110	4
OSGCR 6036-H		60	36	15	80	3
OSGCR 6636-H		66	36	15	85	3
OSGCR 7236-H		72	36	15	90	3
OSGCR 8436-H		84	36	15	100	4
OSGCR 9636-H		96	36	15	110	4
OSGCL 6642-H		66	42	15	90	3
OSGCL 7242-H		72	42	15	95	3
OSGCL 8442-H		84	42	15	105	4
OSGCL 9642-H		96	42	15	115	4
OSGCR 6642-H		66	42	15	90	3
OSGCR 7242-H		72	42	15	95	3
OSGCR 8442-H		84	42	15	105	4
OSGCR 9642-H		96	42	15	115	4

Reception Gallery Options

RECEPTION GALLERY PAPER SORTER INSERT

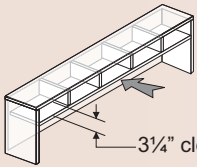

- Field installed
- Not available for Corner Galleries







Product Code	List Price	Dimensions			Wt Cube	
		W	D	H	lbs	ft ³
GPS 24-H		22	10¼	4½	14	2
GPS 30-H		28	10¼	4½	17	2
GPS 36-H		34	10¼	4½	20	2
GPS 42-H		40	10¼	4½	23	2
GPS 48-H		46	10¼	4½	26	2
GPS 54-H		52	10¼	4½	29	2
GPS 60-H		58	10¼	4½	32	2
GPS 66-H		64	10¼	4½	35	2
GPS 72-H		70	10¼	4½	38	2
GPS 78-H		76	10¼	4½	41	2

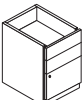
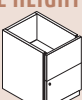
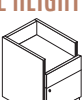

Pedestals

Features:

- Pedestal standard with all drawers locking
- Five-sided drawer construction
- Full extension ball bearing slides on all drawers
- File drawers accommodate letter /legal filing
- Pencil tray standard in upper box drawer
- 5 wheel anti-tip feature on mobile pedestals
- Mobile pedestal top not available in Pattern laminates (see page 4)
- Black integral pull standard. For optional silver finish add suffix (/FPS) to product code
- Optional surface-mounted handles available at \$20 each (see page 5)
- Shipped assembled

	Product Code	List Price	Dimensions W D H	Wt lbs	Cube ft ³
HANGING PEDESTAL - BOX / BOX 	H2B-H		15½ 19 14	40	4
HANGING PEDESTAL - BOX / FILE 	HBF-H		15½ 19 19	55	4
HANGING PEDESTAL - FILE 	HF-H		15½ 19 14	45	4
FULL HEIGHT PEDESTAL - BOX / BOX / FILE 	F2BF-H		15½ 19 28	85	6
FULL HEIGHT PEDESTAL - FILE / FILE 	F2F-H		15½ 19 28	85	6
FULL HEIGHT PEDESTAL - SHELF / BOX / FILE 	FSBF-H		15½ 19 28	80	7
MOBILE PEDESTAL - BOX / FILE  - 5/8" thick top	MBF-H		15½ 19 21½	80	7
MOBILE PEDESTAL - BOX / BOX / FILE  - 5/8" thick top	M2BF-H		15½ 19 27¾	95	7
MOBILE PEDESTAL - FILE / FILE  - 5/8" thick top	M2F-H		15½ 19 27¾	95	7
MOBILE PEDESTAL - SHELF / BOX / FILE  - 5/8" thick top	MSBF-H		15½ 19 27¾	95	7

Lateral Files - Under Desk, Integrated and Stand Alone







Features:

- 1" thick top
- Steel drawers
- Anti-tip interlock system
- Heavy duty full extension ball bearing drawer slides
- Accommodates letter and legal filing
- Integrated 2-drawer lateral file is available in 20" and 24" depth to match adjacent items
- Stand Alone lateral files are designed to be used with each other so base and grain pattern match
- Black integral pull standard. For optional silver finish add suffix (/FPS) to product code
- Optional surface-mounted handles available at \$20 each (see page 5)
- Shipped assembled



2-drawer integrated lateral file







HAVEN

	Product Code	List Price	Dimensions			Wt Cube	
			W	D	H	lbs	ft ³
2-DRAWER LATERAL FILE - UNDER DESK  <ul style="list-style-type: none"> - Fits below 20", 24" or 30" deep desk shell - Vertical grain standard on fronts - Locking 	LFT 30-H		30	19	28	105	13
	LFT 36-H		36	19	28	125	15
2-DRAWER LATERAL FILE - INTEGRATED  <ul style="list-style-type: none"> - Matches depth and height of adjacent items - Vertical grain standard on fronts - Locking 	LF2 3020-H		30	20	29	105	13
	LF2 3024-H		30	24	29	115	13
	LF2 3620-H		36	20	29	130	15
	LF2 3624-H		36	24	29	140	15
2-DRAWER LATERAL FILE - STAND ALONE  <ul style="list-style-type: none"> - Horizontal grain on drawer fronts - Locking 	SLF2 3020-H		30	20	30	105	13
	SLF2 3620-H		30	20	30	130	15
3-DRAWER LATERAL FILE - STAND ALONE  <ul style="list-style-type: none"> - Horizontal grain on drawer fronts - 2 locks keyed-alike 	SLF3 3020-H		30	20	44	175	18
	SLF3 3620-H		36	20	44	200	21
4-DRAWER LATERAL FILE - STAND ALONE  <ul style="list-style-type: none"> - Horizontal grain on drawer fronts - 2 locks keyed-alike 	SLF4 3020-H		30	20	58	220	24
	SLF4 3620-H		36	20	58	260	29
OPTIONS							
FRONT-TO-BACK FILING HARDWARE  <ul style="list-style-type: none"> - Set of 4 bars for 1 drawer - Order separately for each drawer as required 	FTBF				n/a	n/a	n/a

Lower Storage Units — Under Desk and Freestanding

Features:

- 1" thick top on freestanding units
- 20" and 24" deep units match workstation configurations
- Black integral pull standard. For optional silver finish add suffix (/FPS) to product code
- Optional surface-mounted handles available at \$20 each (see page 5)
- Multi-file storage cabinets are not grain-matched and upper drawers and doors are non-locking only
- For lateral file front to back filing hardware, see page 48
- Shipped assembled

	Product Code	List Price	Dimensions			Wt Cube		
			W	D	H	lbs	ft ³	
STORAGE CABINET - UNDER DESK  <ul style="list-style-type: none"> - Fits below 20", 24" or 30" desk shell - 1 adjustable shelf (33-3/8"w) - Non-locking only 	SCT 30-H		30	19	28	80	13	
	SCT 36-H		36	19	28	90	15	
STORAGE & FILE CABINET - UNDER DESK  <ul style="list-style-type: none"> - Fits below 20", 24" or 30" desk shell - 2 file drawers right - Storage left (18½"w) - 1 adjustable shelf 	<i>Non-locking</i> BSCT-H		36	19	28	110	15	
	<i>Locking (2 locks keyed-alike)</i> BSCTL-H		36	19	28	110	15	
MULTI - FILE STORAGE CABINET - UNDER DESK  <ul style="list-style-type: none"> - Fits below 20", 24" or 30" desk shell - 2 box drawers upper left - Closed storage upper right - Lower locking lateral file drawer 	MFSBT 30-H		30	19	28	105	13	
	MFSFT 30-H		30	19	28	105	13	
STORAGE CABINET  <ul style="list-style-type: none"> - 1 adjustable shelf (33-3/8"w) 	SC 3020-H		30	20	29	85	13	
	SC 3024-H		30	24	29	95	14	
	<i>Non-locking</i> SC 3620-H		36	20	29	100	13	
	SC 3624-H		36	24	29	110	15	
	<i>Locking</i> SCL 3020-H		30	20	29	85	13	
	SCL 3024-H		30	24	29	95	14	
	SCL 3620-H		36	20	29	100	13	
	SCL 3624-H		36	24	29	110	15	
STORAGE & FILE CABINET  <ul style="list-style-type: none"> - 2 file drawers right - Storage left (18½"w) - 1 adjustable shelf 	<i>Non-locking</i> BSC 3620-H		36	20	29	115	13	
	BSC 3624-H		36	24	29	125	15	
	<i>Locking (2 locks keyed-alike)</i> BSCL 3620-H		36	20	29	115	13	
	BSCL 3624-H		36	24	29	125	15	
MULTI - FILE STORAGE CABINET  <ul style="list-style-type: none"> - 2 box drawers upper left - Closed storage upper right (12½"w) - Lower locking lateral file drawer 	MFSB 3020-H		30	20	29	105	13	
	MFSB 3024-H		30	24	29	105	13	
	MFSF 3020-H		30	20	29	105	13	
	MFSF 3024-H		30	24	29	105	13	
	 <ul style="list-style-type: none"> - File drawer upper left - Closed storage upper right (12½"w) - Lower locking lateral file drawer 							

Storage Towers - 24" Wide

Features:

- 1" thick top
- Doors standard non-locking. For lock option add suffix (/L) to product code
- Frosted doors non-locking only
- Black integral pull standard. For optional silver finish add suffix (/FPS) to product code
- Optional surface-mounted handles available at \$20 each (see page 5)
- Shipped assembled

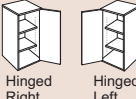
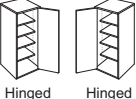
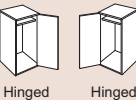
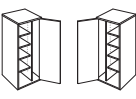
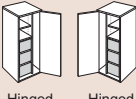
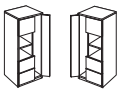
		Product Code	List Price	Dimensions W D H	Wt Cube lbs ft ³
 <p>STORAGE TOWER - 48" and 54" HIGH - 2 full-width adjustable shelves (21½" w)</p>	Hinged Right	ST 242048R-H		24 20 48	160 15
		ST 242448R-H		24 24 48	165 17
		ST 242054R-H		24 20 54	170 17
		ST 242454R-H		24 24 54	180 19
	Hinged Left	ST 242048L-H		24 20 48	160 15
		ST 242448L-H		24 24 48	165 17
		ST 242054L-H		24 20 54	170 17
		ST 242454L-H		24 24 54	180 19
 <p>STORAGE TOWER - 65" and 72" HIGH - 4 full-width adjustable shelves (21½" w)</p>	Hinged Right	ST 242065R-H		24 20 65	175 21
		ST 242465R-H		24 24 65	180 23
		ST 242072R-H		24 20 72	180 23
		ST 242472R-H		24 24 72	190 25
	Hinged Left	ST 242065L-H		24 20 65	175 21
		ST 242465L-H		24 24 65	180 23
		ST 242072L-H		24 20 72	180 23
		ST 242472L-H		24 24 72	190 25
 <p>WARDROBE TOWER - 48" and 54" HIGH - Full-width coat hanger bar (21½" w)</p>	Hinged Right	WT 242048R-H		24 20 48	150 15
		WT 242448R-H		24 24 48	155 17
		WT 242054R-H		24 20 54	160 17
		WT 242454R-H		24 24 54	170 19
	Hinged Left	WT 242048L-H		24 20 48	150 15
		WT 242448L-H		24 24 48	155 17
		WT 242054L-H		24 20 54	160 17
		WT 242454L-H		24 24 54	170 19
 <p>STORAGE & WARDROBE TOWER - 65" and 72" HIGH - 4 adjustable shelves (14-1¼"w) - Coat hanger bar (6 3/8" w)</p>	Hinged Right	SW 242065R-H		24 20 65	175 21
		SW 242465R-H		24 24 65	180 23
		SW 242072R-H		24 20 72	180 23
		SW 242472R-H		24 24 72	190 25
	Hinged Left	SW 242065L-H		24 20 65	175 21
		SW 242465L-H		24 24 65	180 23
		SW 242072L-H		24 20 72	180 23
		SW 242472L-H		24 24 72	190 25
 <p>STORAGE, WARDROBE & FILE TOWER - 65" and 72" HIGH - 1 adjustable shelf (14-1¼"w) - 3 letter/legal file drawers - Coat hanger bar (6 3/8" w) - Full width door</p>	Hinged Right	SWF 242065R-H		24 20 65	190 21
		SWF 242465R-H		24 24 65	195 23
		SWF 242072R-H		24 20 72	195 23
		SWF 242472R-H		24 24 72	205 25
	Hinged Left	SWF 242065L-H		24 20 65	190 21
		SWF 242465L-H		24 24 65	195 23
		SWF 242072L-H		24 20 72	195 23
		SWF 242472L-H		24 24 72	205 25
 <p>WARDROBE, FILE & STORAGE TOWER - 65" and 72" HIGH - Upper closed storage - Middle open storage - Lower letter/legal file drawers, locking - Coat hanger bar (6-3/8") - Separate wardrobe door, available non-locking only</p>	Hinged Right	WFS 242065R-H		24 20 65	175 21
		WFS 242465R-H		24 24 65	180 23
		WFS 242072R-H		24 20 72	180 23
		WFS 242472R-H		24 24 72	190 25
	Hinged Left	WFS 242065L-H		24 20 65	175 21
		WFS 242465L-H		24 24 65	180 23
		WFS 242072L-H		24 20 72	180 23
		WFS 242472L-H		24 24 72	190 25



Storage Towers - 30" and 36" Wide

Features:

- 1" thick top
- Doors standard non-locking. For lock option add suffix (/L) to product code and \$68 to list price.
- Frosted doors non locking only
- Black integral pull standard. For optional silver finish add suffix (/FPS) to product code
- Optional surface-mounted handles available at \$20 each (see page 5)
- Shipped assembled

STORAGE TOWER WITH LATERAL FILES - FROSTED GLASS DOORS



- Locking lateral files
- Frosted doors non-locking only
- Door knob finish matches drawer handles
- 2 adjustable shelves
- Front-to-back filing hardware (see page 49)

Note: Door Frame Available in Aluminum Finish only

STORAGE TOWER WITH LATERAL FILES



- Locking lateral files
- Non-locking upper storage
- 2 adjustable shelves (27½" or 33-3/8"w)
- Front-to-back filing hardware (see page 49)

STORAGE TOWER



- 4 full-width adjustable shelves (33-3/8"w)

WARDROBE TOWER



- Full-width wardrobe
- Hat shelf
- Coat hanger bar (33-3/8"w)

STORAGE & WARDROBE TOWER



- 4 adjustable shelves (26"w)
- Coat hanger bar (6-3/8"w)

Product Code	List Price	Dimensions			Wt lbs	Cube ft ³
		W	D	H		
FFS 302065-H /AL		30	20	65	185	24
FFS 302465-H /AL		30	24	65	210	28
FFS 302072-H /AL		30	20	72	205	27
FFS 302472-H /AL		30	24	72	230	31
FFS 362065-H /AL		36	20	65	215	29
FFS 362465-H /AL		36	24	65	240	33
FFS 362072-H /AL		36	20	72	235	32
FFS 362472-H /AL		36	24	72	260	36
FS 302065-H		30	20	65	185	24
FS 302465-H		30	24	65	210	28
FS 302072-H		30	20	72	205	27
FS 302472-H		30	24	72	230	31
FS 362065-H		36	20	65	215	29
FS 362465-H		36	24	65	240	33
FS 362072-H		36	20	72	235	32
FS 362472-H		36	24	72	260	36
ST 362065-H		36	20	65	200	29
ST 362465-H		36	24	65	220	33
ST 362072-H		36	20	72	215	32
ST 362472-H		36	24	72	240	36
WT 362065-H		36	20	65	165	29
WT 362465-H		36	24	65	175	33
WT 362072-H		36	20	72	170	32
WT 362472-H		36	24	72	185	36
SW 362065-H		36	20	65	200	29
SW 362465-H		36	24	65	220	33
SW 362072-H		36	20	72	215	32
SW 362472-H		36	24	72	240	36

Bookcases

Features:

- 1" thick top and shelves
- Adjustable shelves
- Quarter-round and corner-square bookcases have evenly spaced fixed shelves
- Select grain direction on quarter-round and corner-square bookcases to match adjacent units
- Shipped assembled



HAVEN

BOOKCASE

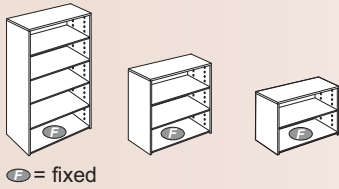

● = fixed

Product Code	List Price	Dimensions W D H	Wt lbs	Cube ft ³
1 adj shelf BC 2429-H		24 14 29	50	9
2 adj shelves BC 2448-H		24 14 48	65	13
4 adj shelves BC 2465-H		24 14 65	90	17
4 adj shelves BC 2472-H		24 14 72	105	20
1 adj shelf BC 3029-H		30 14 29	55	10
2 adj shelves BC 3048-H		30 14 48	75	15
4 adj shelves BC 3065-H		30 14 65	105	20
4 adj shelves BC 3072-H		30 14 72	120	22
1 adj shelf BC 3629-H		36 14 29	60	11
2 adj shelves BC 3648-H		36 14 48	85	18
4 adj shelves BC 3665-H		36 14 65	120	24
4 adj shelves BC 3672-H		36 14 72	135	26
24" shelf - extra ES 24-H		22 13 1	4	1
30" shelf - extra ES 30-H		28 13 1	5	1
36" shelf - extra ES 36-H		34 13 1	6	1

DESK TOP BOOKCASE

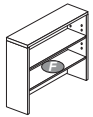

● = fixed

- Use with lateral files and storage cabinets
- 12" clearance above desktop

1 adj shelf XCB 3036-H		30 16 36	70	11
2 adj shelves XCB 3043-H		30 16 43	80	12
1 adj shelves XCB 3636-H		36 16 36	80	12
2 adj shelves XCB 3643-H		36 16 43	90	13
30" shelf - extra XES 30-H		28 13 1	5	1
36" shelf - extra XES 36-H		34 13 1	6	1

QUARTER-ROUND BOOKCASE - LEFT and RIGHT



- Matches depth and height of overheads
- For desk top use
- No bottom shelf



- Matches depth and height of desk/credenza
- 2 fixed shelves

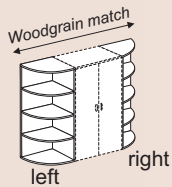

- 16" matches depth and height of overhead
- 20" and 24" match depth and height of towers
- 4 fixed shelves

QRB 1636❖-H		16 16 36	65	5
QRB 1643❖-H		16 16 43	70	6
QRB 2029❖-H		20 20 29	65	5
QRB 2429❖-H		24 24 29	70	6
QRB 1665❖-H		16 16 65	90	8
QRB 2065❖-H		20 20 65	100	20
QRB 2465❖-H		24 24 65	105	22
QRB 1672❖-H		16 16 72	95	9
QRB 2072❖-H		20 20 72	110	22
QRB 2472❖-H		24 24 72	115	24

CORNER-SQUARE BOOKCASE - LEFT and RIGHT

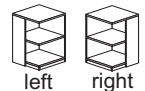

- Matches depth and height of desk/credenza
- 2 fixed shelves

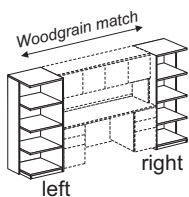

- 20" and 24" match depth and height of towers
- 4 fixed shelves

CSB 2029❖-H		20 20 29	60	9
CSB 2429❖-H		24 24 29	65	10
CSB 2065❖-H		20 20 65	110	20
CSB 2465❖-H		24 24 65	115	22
CSB 2072❖-H		20 20 72	120	22
CSB 2472❖-H		24 24 72	125	24

Select (L) or (R) to match grain direction of adjacent units

Desk Top Panels and Connector Tops

Features:

- 1/4" thick frosted acrylic panels
- Simple surface-mounted attachment secures panel supports to desk top
- Quick, easy field installation
- Desk top panel supports ordered separately; available in Charcoal, Aluminum and Black Finish
- Connector tops are 1" thick



HAVEN

DESK TOP PANEL - 12" HIGH

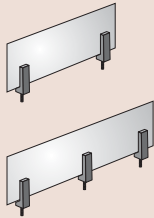

- 2 desk top panel supports required
(order separately - see below)

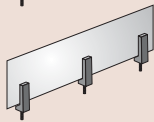

- 3 desk top panel supports required
(order separately - see below)

DESK TOP PANEL - 18" HIGH

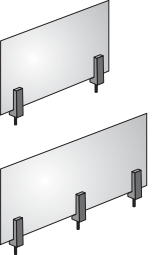

- 2 desk top panel supports required
(order separately - see below)

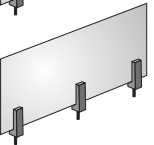

- 3 desk top panel supports required
(order separately - see below)

DESK TOP PANEL SUPPORTS

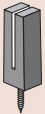

Product Code	List Price	Dimensions W D H	Wt lbs	Cube ft ³
DTP 2412		21 1/4 12	2	1
DTP 3012		27 1/4 12	3	1
DTP 3612		33 1/4 12	4	1
DTP 4212		39 1/4 12	5	1
DTP 4812		45 1/4 12	6	1
DTP 5412		51 1/4 12	7	1
DTP 6012		57 1/4 12	8	1
DTP 6612		63 1/4 12	9	1
DTP 7212		69 1/4 12	10	1
DTP 2418		21 1/4 18	3	1
DTP 3018		27 1/4 18	5	1
DTP 3618		33 1/4 18	6	1
DTP 4218		39 1/4 18	8	1
DTP 4818		45 1/4 18	9	1
DTP 5418		51 1/4 18	11	1
DTP 6018		57 1/4 18	12	1
DTP 6618		63 1/4 18	14	1
DTP 7218		69 1/4 18	15	1
Charcoal finish DTPSC		1 1/2 1 1/2 6	1	0.5
Aluminum finish DTPSA		1 1/2 1 1/2 6	1	0.5
Black finish DTPSB		1 1/2 1 1/2 6	1	0.5
ECT 2424-H		24 28 29	40	17
ECT 3030-H		30 35 29	48	17
HRCT 2424-H		48 24 29	40	2
HRCT 2430-H		54 27 29	45	3
HRCT 3030-H		60 30 29	50	3
QRCT 2424-H		24 24 29	20	1
QRCT 2430-H		24 30 29	25	1
QRCT 3024-H		30 24 29	25	1
QRCT 3030-H		30 30 29	30	1
BCT 2424-H		24 24 n/a	15	1
BCT 3024-H		30 24 n/a	20	1
BCT 3624-H		36 24 n/a	25	2
BCT 4224-H		42 24 n/a	30	2
BCT 2430-H		24 30 n/a	20	1
BCT 3030-H		30 30 n/a	25	2
BCT 3630-H		36 30 n/a	30	2
BCT 4230-H		42 30 n/a	35	2

DESK EXTENSION TABLE

- 30" by 30" X-base standard

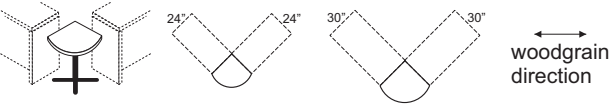

HALF-ROUND CONNECTOR TOP

- 3" diameter post leg standard

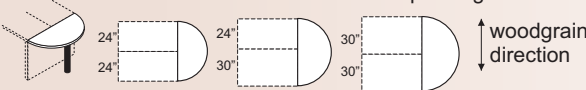

QUARTER-ROUND CONNECTOR TOP

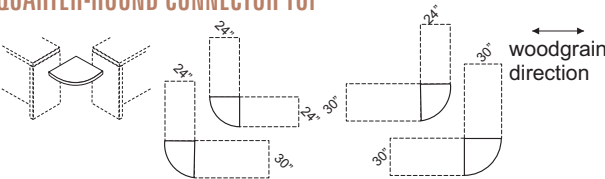

BRIDGE CONNECTOR TOP

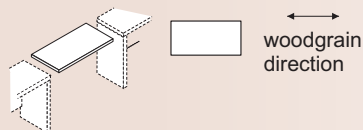

Desk Top Panels and Connector Tops



Features:

- 1/4" thick frosted acrylic panels
- Simple surface-mounted attachment secures panel supports to desk top
- Quick, easy field installation
- Desk top panel supports ordered separately; available in Charcoal, Aluminum and Black finish

DESK TOP PANEL - 12" HIGH

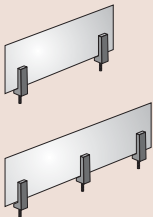

- 2 desk top panel supports required
(order separately - see below)

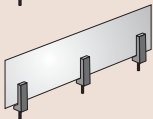

- 3 desk top panel supports required
(order separately - see below)

DESK TOP PANEL - 18" HIGH

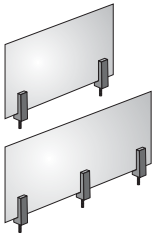

- 2 desk top panel supports required
(order separately - see below)

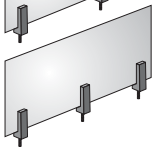

- 3 desk top panel supports required
(order separately - see below)

DESK TOP PANEL SUPPORTS

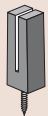

DESK EXTENSION TABLE

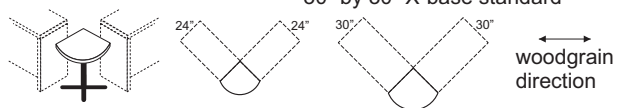

- 30" by 30" X-base standard

ECT 2424
ECT 3030

24	28	29½	50	17
30	35	29½	58	17

HALF-ROUND CONNECTOR TOP

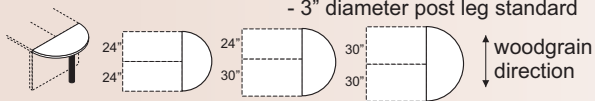

- 3" diameter post leg standard

HRCT 2424
HRCT 2430
HRCT 3030

48	24	29½	50	2
54	27	29½	55	3
60	30	29½	60	3

QUARTER-ROUND CONNECTOR TOP

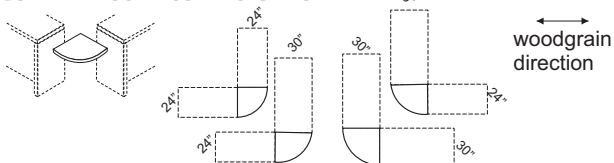

QRCT 2424
QRCT 2430
QRCT 3024
QRCT 3030

24	24	29½	30	1
24	30	29½	35	1
30	24	29½	35	1
30	30	29½	40	1



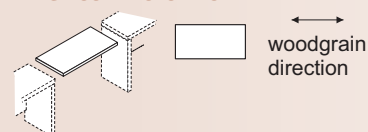



BRIDGE CONNECTOR TOP

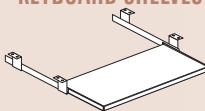
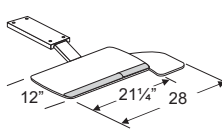
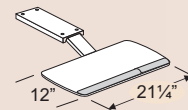

BCT 2424
BCT 3024
BCT 3624
BCT 4224
BCT 2430
BCT 3030
BCT 3630
BCT 4230

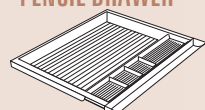
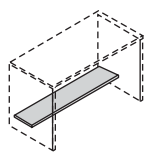
24	24	n/a	25	1
30	24	n/a	30	1
36	24	n/a	35	2
42	24	n/a	40	2
24	30	n/a	30	1
30	30	n/a	35	2
36	30	n/a	40	2
42	30	n/a	45	2

Accessories

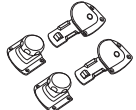





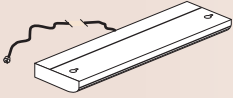

	Product Code	List Price	Dimensions			Wt	
			W	D	H	lbs	ft ³
KEYBOARD SHELVES - STANDARD  <ul style="list-style-type: none"> - Matches lower case finish - Full ext'n ball bearing slides - Requires 3" extra width and 16" deep mounting clearance 	AKS 22		22	12	3	5	1
	AKS 27		27	12	3	7	1
	AKS 30		30	12	3	8	1
DELUXE ARTICULATING KEYBOARD ARM  <ul style="list-style-type: none"> - Quick adjust feature - Positive/negative tilt, swivel & height adjustable - Universal tray for keyboard & mouse - Multiple mouse positions, left or right - Palm support - Black finish 	DARK		28	12	5	18	1
ARTICULATING KEYBOARD ARM  <ul style="list-style-type: none"> - Positive/negative tilt and swivel - Universal tray for keyboard - Compatible with MT mouse tray - Palm support - Requires 19½ deep mounting clearance - Black finish 	ARK		21	10	6	15	1
MOUSE TRAY  <ul style="list-style-type: none"> - Attaches to ARK on left or right - Multi-position mounting 	MT		7	12	1	3	1
PENCIL DRAWER  <ul style="list-style-type: none"> - Shallow profile - ¾ extension ball bearing slides - 21" W x 16" D x 2" H - Requires 22½" wide and 16½ deep mounting clearance - Black finish 	APD		21	16	2	5	1
DESK SHELF  <ul style="list-style-type: none"> - Will not interfere with hanging box/file pedestal - Requires on-site installation - AS 78, AS 84 and AS 96 shelves are 2-piece - Does not fit under extended corner desk shells or corner units 	AS 24-H		22	12	1	10	1
	AS 30-H		28	12	1	12	1
	AS 36-H		34	12	1	14	1
	AS 42-H		40	12	1	16	1
	AS 48-H		46	12	1	18	1
	AS 54-H		52	12	1	19	1
	AS 60-H		58	12	1	20	1
	AS 66-H		64	12	1	22	1
	AS 72-H		70	12	1	24	1
	AS 78-H		(2)37½	12	1	26	1
	AS 84-H		(2)40½	12	1	28	1
AS 96-H		(2)46½	12	1	32	1	
GROMMET  <ul style="list-style-type: none"> - Field installed - Requires 2¾" diameter hole - Black finish 	GR		2¾" Dia	5/8		n/a	n/a
WIRE MANAGEMENT CHANNEL  <ul style="list-style-type: none"> - Field installed - attached to back panel - 12" J-channel with mounting screws - Conceals wires beneath desk top 	WMC		n/a	n/a	n/a	n/a	n/a
HORIZONTAL WIRE MANAGEMENT  <ul style="list-style-type: none"> - Set of 5; screw-on cable ties for under-desk use - Field installed-attached to underside of top 	HWM		n/a	n/a	n/a	0.5	0.5
TABLE GANGING MECHANISM  <ul style="list-style-type: none"> - Set of 2; field installed to connect two tables - Low profile; with quick release knob - Hide-away connector plate rotates under worksurface when not in use 	TGM		4.5	2.5	0.25	1	0.5

Accessories

TASK LIGHTS

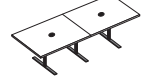

Use with 30" to 42" overhead -
Use with 42" to 78" overhead -

Product Code	List Price	Dimensions			Wt lbs	Cube ft ³
		W	D	H		
TL 24		24	6	2	10	1/2
TL 37		37	6	2	20	1/2
KEYED-ALIKE KITS						
 <ul style="list-style-type: none"> - Provides single key workstation access - Field installed - Replaces random-keyed locks - Units can be quickly and easily re-keyed using a 'lock core removal' key (included with kit) - Determine correct number of keyed-alike locks required per office by referring to product illustrations (Note: some units have multiple locks - see chart on page 7) 						
1 lock KAK-1		n/a			n/a	n/a
2 locks KAK-2		n/a			n/a	n/a
3 locks KAK-3		n/a			n/a	n/a
4 locks KAK-4		n/a			n/a	n/a
5 locks KAK-5		n/a			n/a	n/a
6 locks KAK-6		n/a			n/a	n/a
HANDLE RETROFIT KITS						
H-WHB						
 <ul style="list-style-type: none"> - Waterfall Handle - Black - Field installed - Drilling template included 						
H-OPB						
 <ul style="list-style-type: none"> - Open Pull - Black - Field installed - Drilling template included 						
H-OPN						
 <ul style="list-style-type: none"> - Open Pull - Nickel - Field installed - Drilling template included 						
H-BPA						
 <ul style="list-style-type: none"> - Bar Pull - Aluminum - Field installed - Drilling template included 						
H-RPA						
 <ul style="list-style-type: none"> - Rod Pull - Aluminum - Field installed - Drilling template included 						
POWER STATION						
 <ul style="list-style-type: none"> - For use with standard Conference Table Tops only - Compatible with all Table Base styles except Panel H-Base - Factory installed in standard locations only (see below) - Three grounded outlets, RJ45 and RJ11 Jacks - 10 ft power cord 						
 <ul style="list-style-type: none"> - 1 Power Station centered on 1-piece top or centered on one half of 2-piece top - Add suffix (/PS1) to Conference Table Top product code 						
 <ul style="list-style-type: none"> - 2 Power Stations centered on each half of 2-piece top - Add suffix (/PS2) to Conference Table Top product code 						
/PS-1		4.25 dia	1.5	0.5	n/a	
/PS-2		4.25 dia (x2)	1.5	0.5	n/a	

Conference Table and Meeting Table Tops



Features:

- Table tops available in 5 shapes with 3 edge details
- Table tops longer than 96" are 2-piece and are not grain-matched
- All tops have matching 2.5 mm edgebanding
- For base options see page 58
- Power station can be factory installed in standard locations on Conference Table Tops (see page 56)

Top Edge Detail

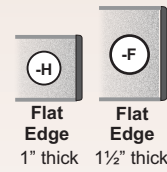

CONFERENCE TABLE TOPS - RECTANGULAR

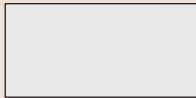

CONFERENCE TABLE TOPS - RACETRACK



CONFERENCE TABLE TOPS - BOATSHAPE

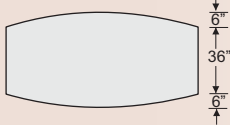

MEETING TABLE TOPS - ROUND

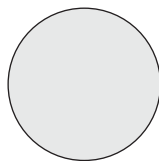

MEETING TABLE TOPS - SQUARE

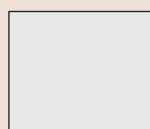

Top Features	Seating Capacity	Product Code	List Price	Dimensions L W	Wt lbs	Cube ft ³	
1 - piece top 1 1/2" thick	6	RC 6036 ▲		60 36	89	3	
	6	RC 6636 ▲		66 36	98	4	
	6	RC 7236 ▲		72 36	113	4	
	8	RC 8436 ▲		84 36	123	4	
	8	RC 9636 ▲		96 36	134	5	
	8	RC 8442 ▲		84 42	145	5	
	8	RC 9642 ▲		96 42	161	6	
	8	RC 8448 ▲		84 48	155	5	
	8	RC 9648 ▲		96 48	171	6	
	2 - piece top 1 1/2" thick	10	RC 12036 ▲		120 36	185	7
		10	RC 14436 ▲		144 36	220	8
		10	RC 12048 ▲		120 48	242	8
		10	RC 14448 ▲		144 48	285	9
		14	RC 16848 ▲		168 48	310	10
14		RC 19248 ▲		192 48	342	11	
1 - piece top 1 1/2" thick	6	RT 6036 ▲		60 36	89	3	
	6	RT 6636 ▲		66 36	98	4	
	6	RT 7236 ▲		72 36	113	4	
	8	RT 8436 ▲		84 36	123	4	
	8	RT 9636 ▲		96 36	134	5	
	8	RT 8442 ▲		84 42	145	5	
	8	RT 9642 ▲		96 42	161	6	
	8	RT 8448 ▲		84 48	155	5	
	8	RT 9648 ▲		96 48	171	6	
	2 - piece top 1 1/2" thick	10	RT 12036 ▲		120 36	185	7
		10	RT 14436 ▲		144 36	220	8
		10	RT 12048 ▲		120 48	242	8
		10	RT 14448 ▲		144 48	285	9
		14	RT 16848 ▲		168 48	310	10
14		RT 19248 ▲		192 48	342	11	
1 - piece top 1 1/2" thick	8	BS 8442 ▲		84 42	145	5	
	8	BS 9642 ▲		96 42	161	6	
	8	BS 8448 ▲		84 48	155	5	
	8	BS 9648 ▲		96 48	171	6	
	10	BS 12048 ▲		120 48	242	8	
	10	BS 14448 ▲		144 48	285	9	
	14	BS 16848 ▲		168 48	310	10	
	14	BS 19248 ▲		192 48	342	11	
1" thick top	3	RD 30-H		30 dia	40	2	
	3	RD 36-H		36 dia	50	2	
	4	RD 42-H		42 dia	60	3	
	5	RD 48-H		48 dia	70	4	
	5	RD 54-H		54 dia	80	5	
1 1/2" thick top	3	RD 30 ▲		30 dia	50	2	
	3	RD 36 ▲		36 dia	65	2	
	4	RD 42 ▲		42 dia	80	3	
	5	RD 48 ▲		48 dia	95	4	
	5	RD 54 ▲		54 dia	110	5	
1" thick top	4	SQ 30-H		30 30	50	2	
	4	SQ 36-H		36 36	60	2	
	4	SQ 42-H		42 42	70	3	
	4	SQ 48-H		48 48	80	4	
	8	SQ 54-H		54 54	90	5	
1 1/2" thick top	4	SQ 30 ▲		30 30	60	2	
	4	SQ 36 ▲		36 36	75	2	
	4	SQ 42 ▲		42 42	90	3	
	4	SQ 48 ▲		48 48	105	4	
	8	SQ 54 ▲		54 54	120	5	

Select edge code: -F,

Conference Table Bases

Features:

- Table bases available in 7 styles: 4 laminate panel bases and 3 metal bases
- Metal T-Base, X-Base and 6" Post Leg also available in optional silver finish - add suffix (/SL) to product code.



PANEL H-BASE

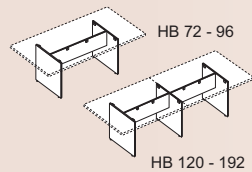

- Base code matches table top length
- End panels & center support 1" thick

PANEL V-BASE

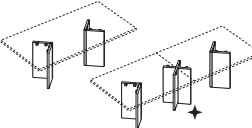

- 1-piece top requires 1 V-Base (pair)
- V-base panels 1 1/2" thick with steel corner post
- + 2-piece top also requires 1 X-Base for center support

PANEL X-BASE

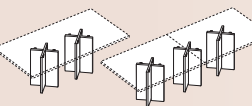

- 1-piece top requires 2 X-Bases (use only on tops 72" or longer)
- 2-piece top requires 3 X-Bases
- X-base panels 1 1/2" thick

RECTANGULAR TABLE BASE

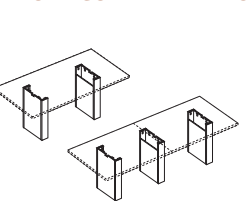

- 1-piece top requires 2 Bases
- 2-piece top requires 3 Bases
- Right hinged Door for cable management access with magnetic touch latch.

Note- Not compatible with Round and Square Meeting Table tops

METAL T-BASE

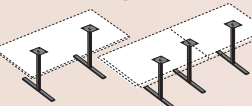

- 1-piece top requires 2 T-Bases
- 2-piece top requires 3 T-Bases
- 3" diameter post with 35" W or 20" W low-profile foot
- Black powder-coat finish standard
- *TL-20 is for use with 20" and 24" deep tops only (see page 109)

METAL X-BASE

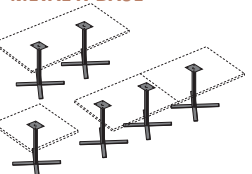





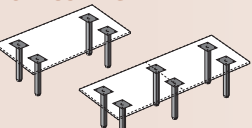

- 1-piece top larger than 48" wide requires 2 X-Bases
- 2-piece top requires 3 X-Bases
- 3" diameter post with 35" x 35" or 30" X 30" low-profile foot
- Black powder-coat finish
- *XL-30 is for 30" round and 30" square meeting tables standard

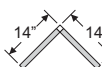
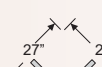
6" POST LEG



- 1-piece top requires 4 Post Legs
- 2-piece top requires 6 Post Legs
- 6" diameter with 2 levelers for added stability
- Black powder-coat finish standard

Product Code	List Price	Dimensions			Wt lbs	Cube ft ³
		W	D	H		
- supports	HB 60	30	24	28	50	3
1 - piece top	HB 66	30	24	28	55	3
	HB 72	43	24	28	55	3
	HB 84	43	24	28	55	3
	HB 96	43	24	28	55	3
- supports	HB 120	84	24	28	90	4
2 - piece top	HB 144	84	24	28	90	4
	HB 168	120	24	28	110	5
	HB 192	140	24	28	120	5
	VB 666	15	15	28	30	2
	XB	27	27	28	40	2
	RTB 18-H	4	18	28	50	3
-for use with tables 36" deep						
	RTB 24-H	4	24	28	50	4
-for use with tables 42" & 48" deep						
	TL-35	35	3 1/2	28	25	4
	TL-20*	20	3 1/2	28	20	4
	XL-35	35	35	28	35	16
	XL-30*	30	30	28	31	13
	PL-6	6" dia		28	10	1



DISTINCTIVE



Tables with Aluminum Legs and Acrylic Panels

Features:

- All tops 1" thick with 2.5mm edgebanding
- Aluminum legs with clear anodized finish; integrated wire management capabilities
- For horizontal wire management see page 55
- Tables available Mobile or Stationary. Table heights are standard at 29" (Mobile aluminum legs are shorter to accommodate caster height)
- Standard without grommet. For field-installed grommet option see page 55
- For field installed table ganging mechanism see page 55



Flat Edge
1" thick



RECTANGULAR TABLES WITH ALUMINUM LEGS

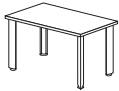

- Mobile Tables: for legs with casters add suffix (/M) to product code (standard with 2 locking casters)
 - Tables 60" and wider come with a metal reinforcement channel
- 1" thick top

Product Code	List Price	Dimensions			Wt lbs	Cube ft ³
		W	D	H		
TALRC 4224-H		42	24	29	41	6
TALRC 4824-H		48	24	29	44	6
TALRC 5424-H		54	24	29	48	6
TALRC 6024-H		60	24	29	59	7
TALRC 6624-H		66	24	29	63	7
TALRC 7224-H		72	24	29	66	7
TALRC 4230-H		42	30	29	47	7
TALRC 4830-H		48	30	29	51	7
TALRC 5430-H		54	30	29	55	7
TALRC 6030-H		60	30	29	68	8
TALRC 6630-H		66	30	29	72	8
TALRC 7230-H		72	30	29	77	8

ADD-ON ACRYLIC END PANEL

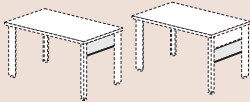

- Use one to create a single end panel on TALRC table
- Use two to create a double end panel on TALRC table

AEP 24		16	1/4	10	1	1
AEP 30		22	1/4	10	2	1

ADD-ON ACRYLIC MODESTY PANEL

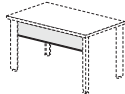

- Use to create a single modesty on TALRC table
- Can not be used for double modesty application

AMP 42		34	1/4	10	3	1
AMP 48		40	1/4	10	4	1
AMP 54		46	1/4	10	4	1
AMP 60		52	1/4	10	5	1
AMP 66		58	1/4	10	5	1
AMP 72		64	1/4	10	6	1

ROUND TABLES WITH ALUMINUM LEGS



- Standard with leveling glides
 - Mobile Tables: for legs with casters add suffix (/M) to product code
 - Mobile table standard with 2 locking casters
- 1" thick top

TALRD 30-H		30" dia		29	56	6
TALRD 36-H		36" dia		29	66	6
TALRD 42-H		42" dia		29	76	7
TALRD 48-H		48" dia		29	86	8
TALRD 54-H		54" dia		29	96	9

SQUARE TABLES WITH ALUMINUM LEGS



- Standard with leveling glides
 - Mobile Tables: for legs with casters add suffix (/M) to product code
 - Mobile table standard with 2 locking casters
- 1" thick top

TALSQ 30-H		30	30	29	66	6
TALSQ 36-H		36	36	29	76	6
TALSQ 42-H		42	42	29	86	7
TALSQ 48-H		48	48	29	96	8
TALSQ 54-H		54	54	29	106	9

Select edge code: -F,

Conference Room and Miscellaneous Furniture

Features:







- All tops 1" or thick with 2.5mm edgebanding
- Furniture with 1" thick tops have black integral pull standard.
For optional silver add suffix (/FPS) to product code

Top Edge Detail



Flat Edge
1" thick

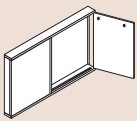
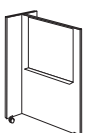

		TOP	Product Code	List Price	Dimensions W D H	Wt lbs	Cube ft ³
LECTERN  <ul style="list-style-type: none"> - 2 interior shelves - 1 grommet - Locking casters - Shipped assembled 		1" thick top	LT 1818-H		18 18 44	85	8
END TABLE  <ul style="list-style-type: none"> - Full width center support - 6" high 		1" thick top	ET 2424-H ET 3030-H		24 24 18 30 30 18	40 50	2 3
COFFEE TABLE  <ul style="list-style-type: none"> - Full width center support - 6" high 		1" thick top	CT 4220-H CT 4824-H		42 20 16 48 24 16	50 55	3 3
PRINTER TABLE  <ul style="list-style-type: none"> - 3 (8½" w x 2¾" h) paper sorter cubbies - 1 pullout shelf with paper access (height clearance 12½" above; 8" below) - Cable management grommets in back - Shipped assembled 		1" thick top	PT 3024-H PT 3624-H		30 24 29 36 24 29	100 120	13 16
SINGLE SERVICE CART - MOBILE  <ul style="list-style-type: none"> - Upper pull-out shelf - 1 box drawer - Storage with adjustable shelf - Non-locking - Shipped assembled 		1" thick top	SS 1921-H		19 21 36	85	12
DOUBLE SERVICE CART - MOBILE  <ul style="list-style-type: none"> - Upper pull-out shelf - 2 box drawers - Double storage with adjustable shelves - Non-locking - Shipped assembled 		1" thick top	SS 3221-H		32 21 36	120	20
MARKER BOARD  <ul style="list-style-type: none"> - Whiteboard for dry-erase markers - Ledge for eraser & marker storage - Left door - tackable corkboard - Right door - flipchart pegs (mounting holes on 17½" centres) - 2-piece cleat wall-mount system - Not available in Pattern laminates - Shipped assembled 		1" thick top	MB 5040-H		50 5 40	140	10
HAVEN PLUS - Select edge code: -F							
MOBILE WHITEBOARD/DIVIDER  <ul style="list-style-type: none"> - 36" x 36" whiteboard - Marker tray - Shipped ready-to-assemble 			MWD 4872-H		48 28 72	120	10

Worksurfaces

Features:

- An economical worksurface alternative
- For use with structural panel system
- 1" thick laminate with 2.5 mm edgebanding
- Sizes are **exact** finished dimensions
- Standard without cable management grommets (see page 55 for field-installed grommet option)
- Attaching hardware not included
- Tops are not pre-drilled for attachment of leg support

Worksurface Edge Detail



Flat Edge
1" thick

	Product Code 1" THICK	List Price	Wt lbs	Exact Dimensions D1 W1 W2 D2	Cube ft ³
RECTANGULAR TOP - 18" DEEP Steel lateral files tops 	WSR 3018-H		15	18 30	1
	WSR 3618-H		18	18 36	1
	WSR 4218-H		21	18 42	2
	WSR 7218-H		36	18 72	3
RECTANGULAR TOP - 24" DEEP 	WSR 1824-H		11	24 18	1
	WSR 2424-H		14	24 24	1
	WSR 3024-H		18	24 30	1
	WSR 3624-H		21	24 36	1
	WSR 4224-H		25	24 42	2
	WSR 4824-H		28	24 48	2
	WSR 5424-H		32	24 54	2
	WSR 6024-H		35	24 60	3
	WSR 6624-H		39	24 66	3
	WSR 7224-H		42	24 72	3
RECTANGULAR TOP - 30" DEEP 	WSR 1830-H		13	30 18	1
	WSR 2430-H		18	30 24	1
	WSR 3030-H		22	30 30	2
	WSR 3630-H		26	30 36	2
	WSR 4230-H		31	30 42	2
	WSR 4830-H		35	30 48	3
	WSR 5430-H		39	30 54	3
	WSR 6030-H		44	30 60	3
	WSR 6630-H		48	30 66	3
	WSR 7230-H		53	30 72	4
STRAIGHT CORNER 	WSCS 361818-H		32	18 36 36 18	2
	WSCS 362424-H		32	24 36 36 24	2
	WSCS 422424-H		43	24 42 42 24	3
	WSCS 423030-H		43	30 42 42 30	3
	WSCS 482424-H		56	24 48 48 24	4
	WSCS 483030-H		56	30 48 48 30	4
CURVILINEAR CORNER 	WSCR 361818-H		32	18 36 36 18	2
	WSCR 362424-H		32	24 36 36 24	2
	WSCR 422424-H		43	24 42 42 24	3
	WSCR 423030-H		43	30 42 42 30	3
	WSCR 482424-H		56	24 48 48 24	4
	WSCR 483030-H		56	30 48 48 30	4

Worksurfaces

Features:

- An economical worksurface alternative
- For use with structural panel system
- 1" thick laminate with 2.5 mm edgebanding
- Sizes are **exact** finished dimensions
- Standard without cable management grommets (see page for field-installed grommet option)
- Attaching hardware not included
- Tops are not pre-drilled for attachment of leg support

Worksurface Edge Detail



Flat Edge
1" thick

CURVILINEAR CORNER - EXTENDED LEFT

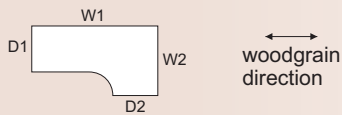

CURVILINEAR CORNER - EXTENDED RIGHT

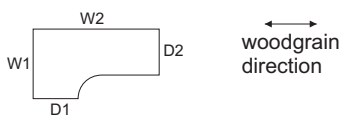

P-TOP - LEFT HAND

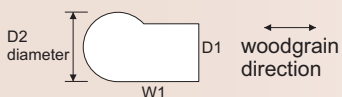

P-TOP - RIGHT HAND

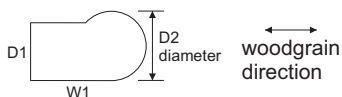

Product Code 1" THICK	List Price	Wt lbs	Exact Dimensions				Cube ft ³
			D1	W1	W2	D2	
WSEC 24603624L-H		53	24	60	36	24	4
WSEC 24663624L-H		58	24	66	36	24	4
WSEC 24723624L-H		63	24	72	36	24	5
WSEC 24604224L-H		62	24	60	42	24	4
WSEC 24664224L-H		68	24	66	42	24	4
WSEC 24724224L-H		73	24	72	42	24	5
WSEC 24604230L-H		62	24	60	42	30	4
WSEC 24664230L-H		68	24	66	42	30	4
WSEC 24724230L-H		74	24	72	42	30	5
WSEC 30604224L-H		62	30	60	42	24	4
WSEC 30664224L-H		68	30	66	42	24	4
WSEC 30724224L-H		74	30	72	42	24	5
WSEC 30604230L-H		62	30	60	42	30	4
WSEC 30664230L-H		68	30	66	42	30	4
WSEC 30724230L-H		74	30	72	42	30	5
WSEC 24366024R-H		53	24	36	60	24	4
WSEC 24366624R-H		58	24	36	66	24	4
WSEC 24367224R-H		63	24	36	72	24	5
WSEC 24426024R-H		62	24	42	60	24	4
WSEC 24426624R-H		68	24	42	66	24	4
WSEC 24427224R-H		73	24	42	72	24	5
WSEC 24426030R-H		62	24	42	60	30	4
WSEC 24426630R-H		68	24	42	66	30	4
WSEC 24427230R-H		74	24	42	72	30	5
WSEC 30426024R-H		62	30	42	60	24	4
WSEC 30426624R-H		68	30	42	66	24	4
WSEC 30427224R-H		74	30	42	72	24	5
WSEC 30426030R-H		62	30	42	60	30	4
WSEC 30426630R-H		68	30	42	66	30	4
WSEC 30427230R-H		74	30	42	72	30	5
WSP 483036L-H		43	30	48		36	3
WSP 603036L-H		53	30	60		36	3
WSP 663036L-H		58	30	66		36	4
WSP 723036L-H		63	30	72		36	4
WSP 483036R-H		43	30	48		36	3
WSP 603036R-H		53	30	60		36	3
WSP 663036R-H		58	30	66		36	4
WSP 723036R-H		63	30	72		36	4

Worksurfaces

Features:

- An economical worksurface alternative
- For use with structural panel system
- 1" thick laminate with 2.5 mm edgebanding
- Sizes are **exact** finished dimensions
- Standard without cable management grommets (see page 56 for field-installed grommet option)
- Attaching hardware not included
- Tops are not pre-drilled for attachment of leg support

Worksurface Edge Detail



Flat Edge
1" thick

	Product Code 1" THICK	List Price	Wt lbs	Exact Dimensions				Cube ft ³
				D1	W1	W2	D2	
D-TOP - 24" DEEP 	WSD 3624-H		21	24	36		1	
	WSD 4224-H		25	24	42		2	
	WSD 4824-H		28	24	48		2	
	WSD 5424-H		32	24	54		2	
	WSD 6024-H		35	24	60		3	
	WSD 6624-H		39	24	66		3	
	WSD 7224-H		42	24	72		3	
D-TOP - 30" DEEP 	WSD 3630-H		26	30	36		2	
	WSD 4230-H		31	30	42		2	
	WSD 4830-H		35	30	48		3	
	WSD 5430-H		40	30	54		3	
	WSD 6030-H		44	30	60		3	
	WSD 6630-H		49	30	66		3	
	WSD 7230-H		53	30	72		4	
D-TOP - 36" DEEP 	WSD 6036-H		53	36	60		4	
	WSD 6636-H		59	36	66		4	
	WSD 7236-H		64	36	72		5	
HALF-ROUND SPANNER 	WSH 4824-H		28	24	48		2	
	WSH 5027-H		33	27	50		3	
	WSH 5427-H		35	27	54		3	
	WSH 6030-H		44	30	60		3	
	WSH 6230-H		45	30	62		3	
QUARTER-ROUND SPANNER 	WSQ 2424-H		14	24	24		1	
	WSQ 2430-H		18	24	30		1	
	WSQ 3024-H		18	30	24		1	
	WSQ 3030-H		22	30	30		2	

OPTIONS:	Product Code	List Price	Dimensions W D H			Wt lbs	Cube ft ³
3" DIAMETER POST LEG <ul style="list-style-type: none"> - Black powder-coat finish 	PL-3		3" dia	28h	5	1	
	PL-6		6" dia	28h	10	1	
6" DIAMETER POST LEG <ul style="list-style-type: none"> - 2 levellers for added stability - Black powder-coat finish 	AL		2.5	3.5	28	4	1
	ALM		2.5	3.5	28	4	1
ALUMINUM LEG WITH LEVELING GLIDE <ul style="list-style-type: none"> - Stationary table application - Integrated wire management capability - Designed to accommodate acrylic panels (see pg 107) 	ALM		2.5	3.5	28	4	1
	ALML		2.5	3.5	28	4	1
ALUMINUM LEG WITH CASTER <ul style="list-style-type: none"> - Mobile table application - 75mm polypro wheel - Integrated wire management capability - Designed to accommodate acrylic panels 	ALM		2.5	3.5	28	4	1
	ALML		2.5	3.5	28	4	1

TERMS AND CONDITIONS

The illustrations, specifications and prices reflect the latest information available at time of publication. Products, prices, materials, colours and specifications are subject to change without notice.

ORDERING INFORMATION

To ensure completeness and accuracy of orders, Woodlore International Inc. requires that all orders be submitted in writing. Telephone orders will not be processed without written confirmation. In the event of a discrepancy between the product code and product description, Woodlore will process the order based on the product code.

ORDER ACKNOWLEDGMENT

Woodlore International Inc. will provide written acknowledgements of all orders. It is the responsibility of the dealer/purchaser to ensure that the information on the acknowledgement is exactly as specified on the purchase order.

ORDER CHANGE/ORDER CANCELLATION REQUESTS

Orders are locked in a Closed Schedule and cannot be changed 7 business days before shipping. Cancellation of an order in a Closed Schedule is not permitted.

PRICING

The prices listed are suggested retail prices and are exclusive of all applicable taxes. Prices and taxes are subject to change without notice.

SHIPPING

Shipments are F.O.B. Woodlore's factory in Brampton, Ontario, Canada unless otherwise stipulated. All deliveries are dock-to-dock. Every effort is made to ensure secure packaging for shipments. Upon delivery, please examine product for damages or shortages. Visible damage must be noted on shipping documents in order to place a freight claim with the carrier.

TERMS

Terms are net 30 days from date of invoice. All invoices will be dated and issued when order is ready for shipping. Any product sold shall remain the property of Woodlore International Inc. until paid for in full.

STORAGE

A storage charge may be applied to orders not picked up within 2 days from ready date.

WEIGHTS AND VOLUMES

Published weights and sizes are approximate. For actual product dimensions, please refer to Page 4 of our Price List.

NON-OBSOLESCENCE AND PRODUCT WARRANTY POLICY

All Woodlore products carry a Lifetime Warranty against defects in materials and workmanship. This warranty covers the repair or replacement, at Woodlore's discretion, of all products which, under conditions of normal use, prove to be defective. Dark, solid-coloured laminates are not recommended for worksurfaces. Our standard warranty will not apply if specified. Woodlore will make every effort to maintain product and finish compatibility as product offerings evolve over time. If for any reason an identical warranty item or finish is not available, a comparable replacement product will be provided.

